

# Davey

ART. NR. 7850003

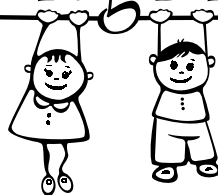

Swing King







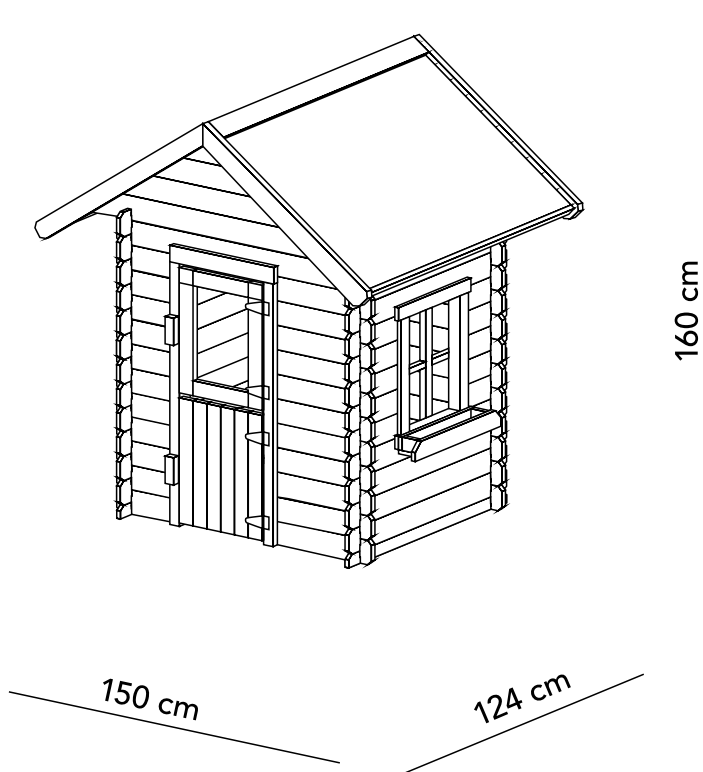

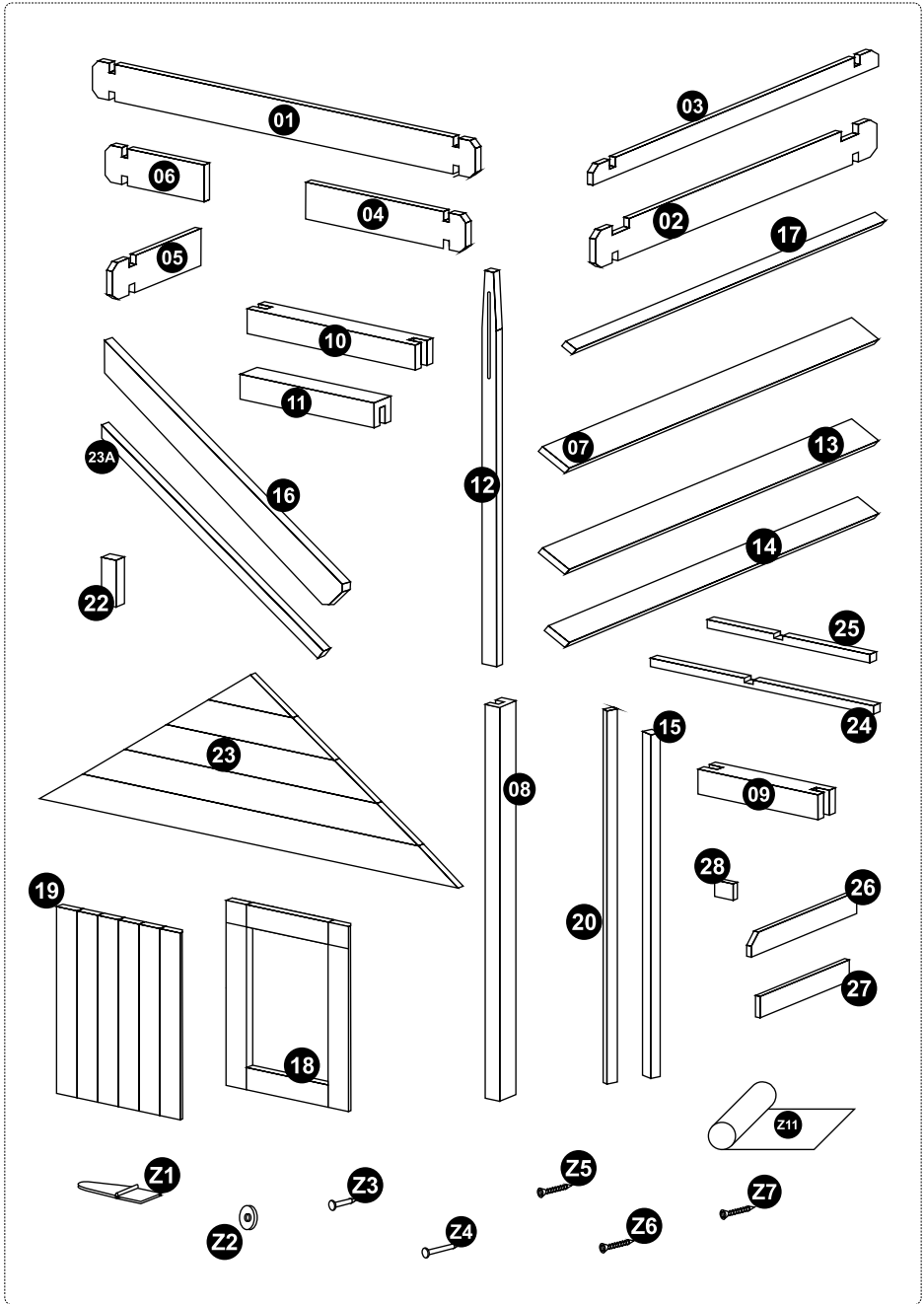

# Davey

---



I: 106,5 cm x 106,5 cm x 135 cm  
E: 150 cm x 124 cm x 160 cm



01	30	1200	X	90	X	15
02	2	1200	X	67	X	15
03	2	1200	X	45	X	15
04	11	490	X	90	X	15
05	10	430	X	90	X	15
06	11	260	X	90	X	15
07	20	1200	X	90	X	15
08	2	945	X	65	X	40
09	1	610	X	65	X	40
10	2	500	X	65	X	40
11	2	375	X	65	X	40
12	2	1200	X	67	X	15
13	1	1200	X	67	X	15
14	1	1200	X	45	X	15
15	1	1066	X	45	X	15
16	4	960	X	65	X	15
17	2	1200	X	25	X	15
18	1	450	X	380	X	30
19	1	450	X	380	X	30
20	1	1000	X	45	X	15
22	2	102	X	45	X	15
23	2	1180	X	458	X	30
23A	4	900	X	50	X	25
24	1	420	X	25	X	15
25	1	335	X	25	X	15
26	1	500	X	90	X	15
27	2	430	X	90	X	15
28	2	75	X	90	X	15
Z1	4					
Z2	2					
Z3	30		2,8x15			
Z4	40		2x30			
Z5	20		3,5x15			
Z6	24		3,5x25			
Z7	59		3,5x35			
Z11	2					

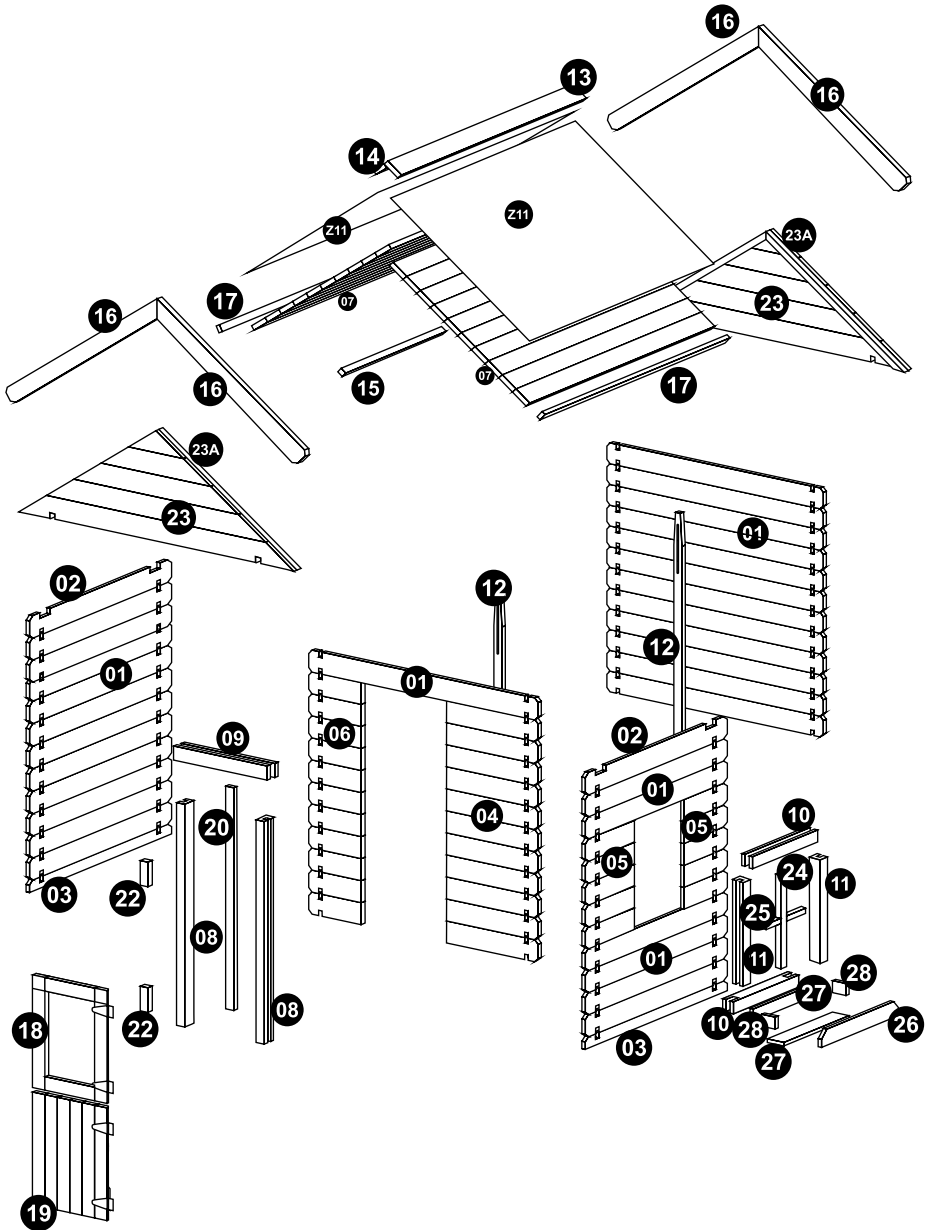

1

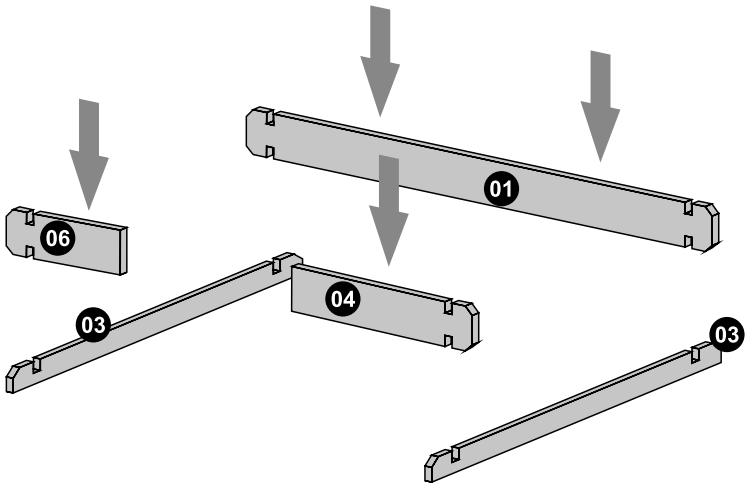

2

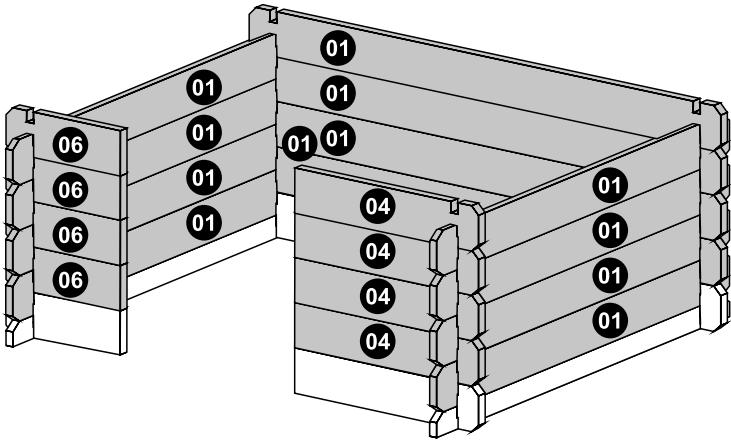

3

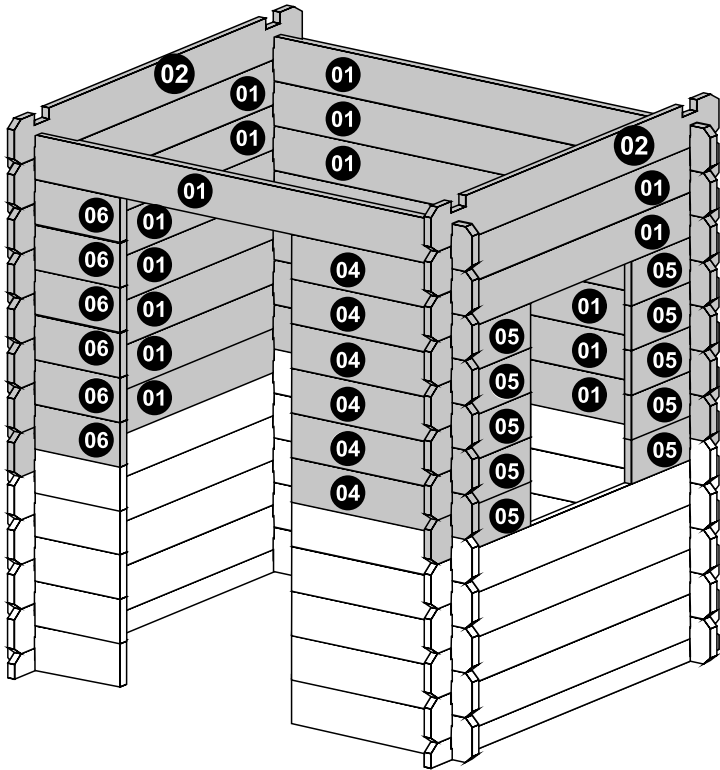



4

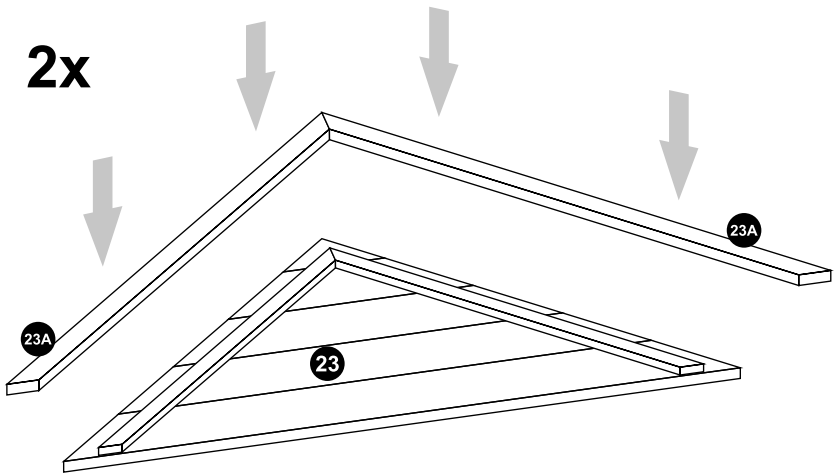

2 x 4 x 1 Z7

2x

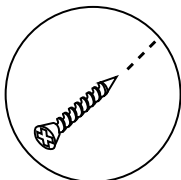
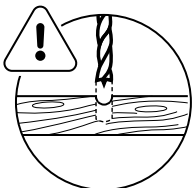
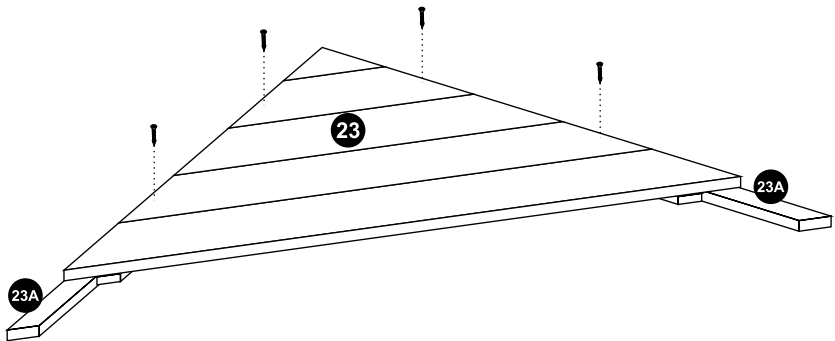

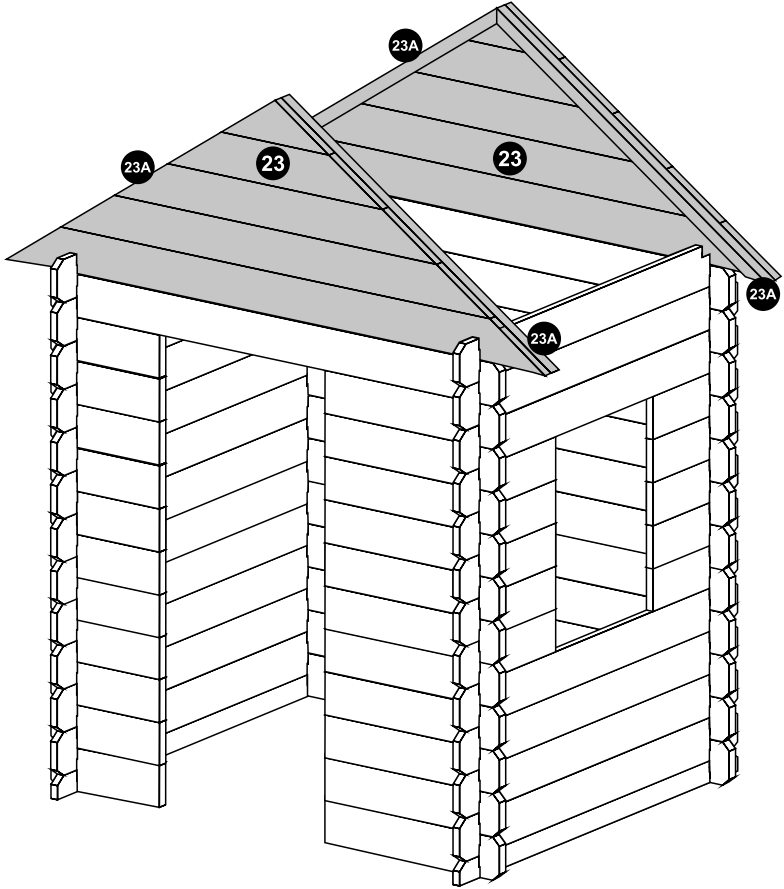

Ø 2,5 mm

5



6

2 x  

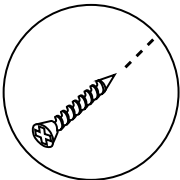
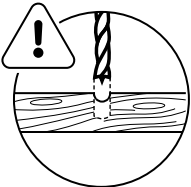
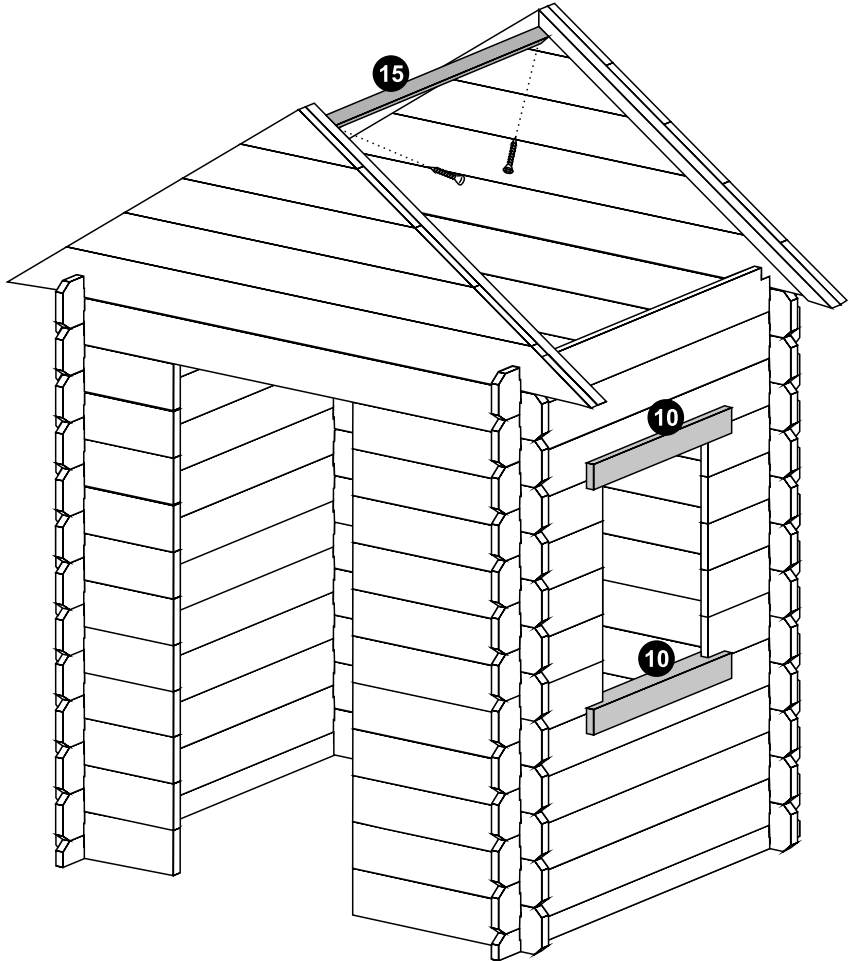

Ø 2,5 mm

7

4 x  **Z7**

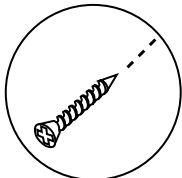
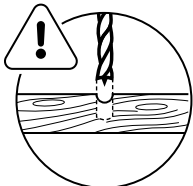
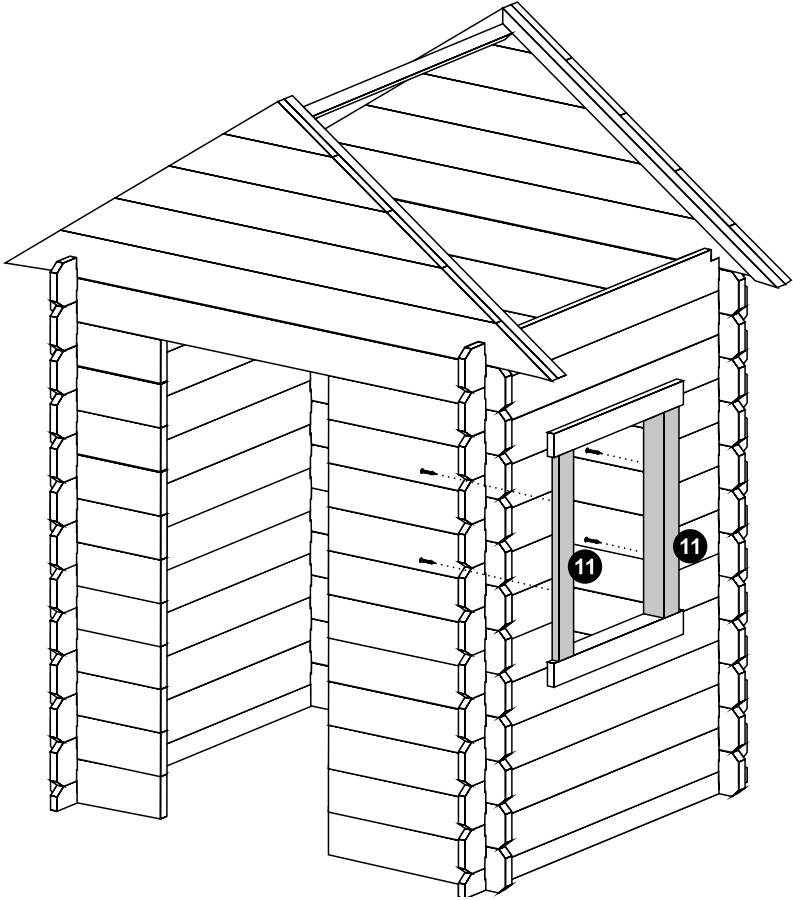

Ø 2,5 mm

8

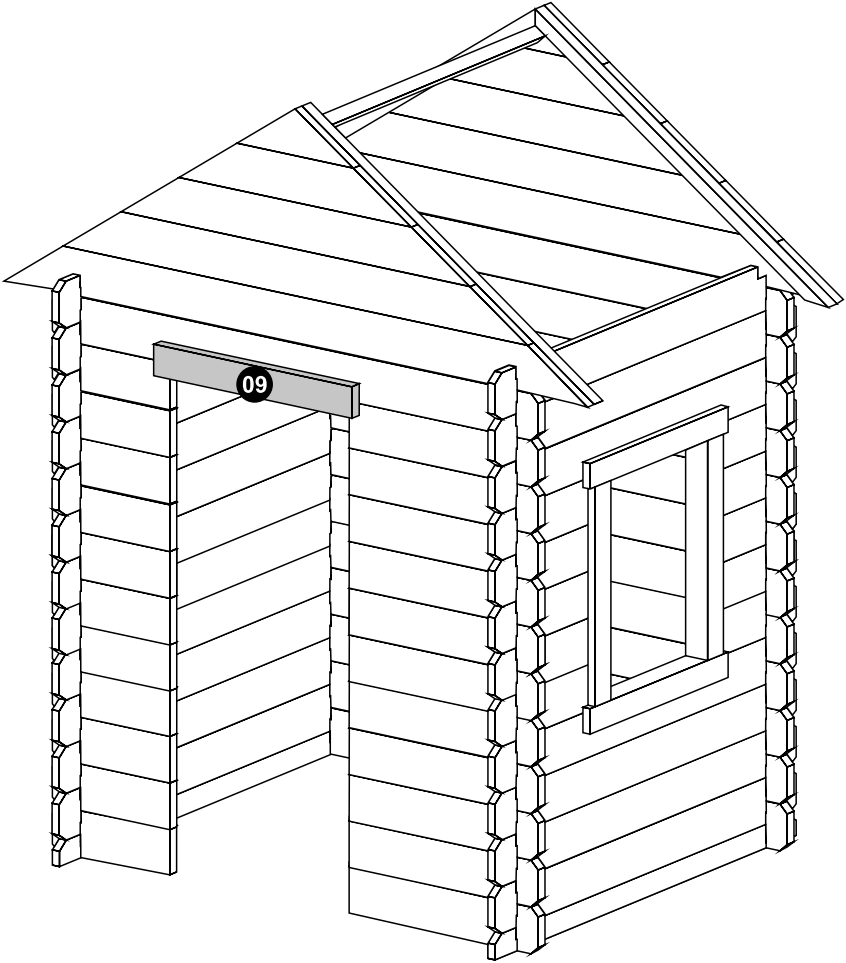

9

8 x  Z7

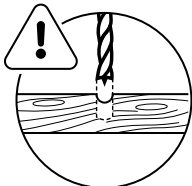
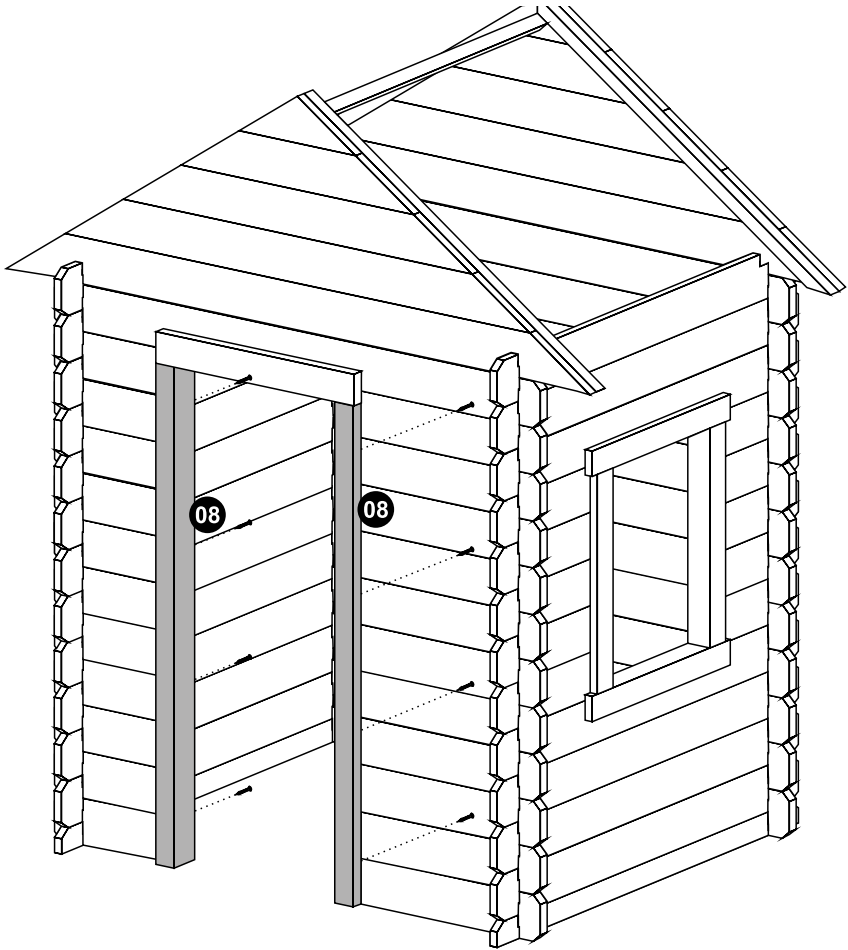

Ø 2,5 mm

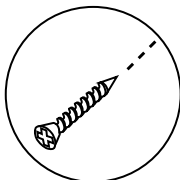

10

20 x  24

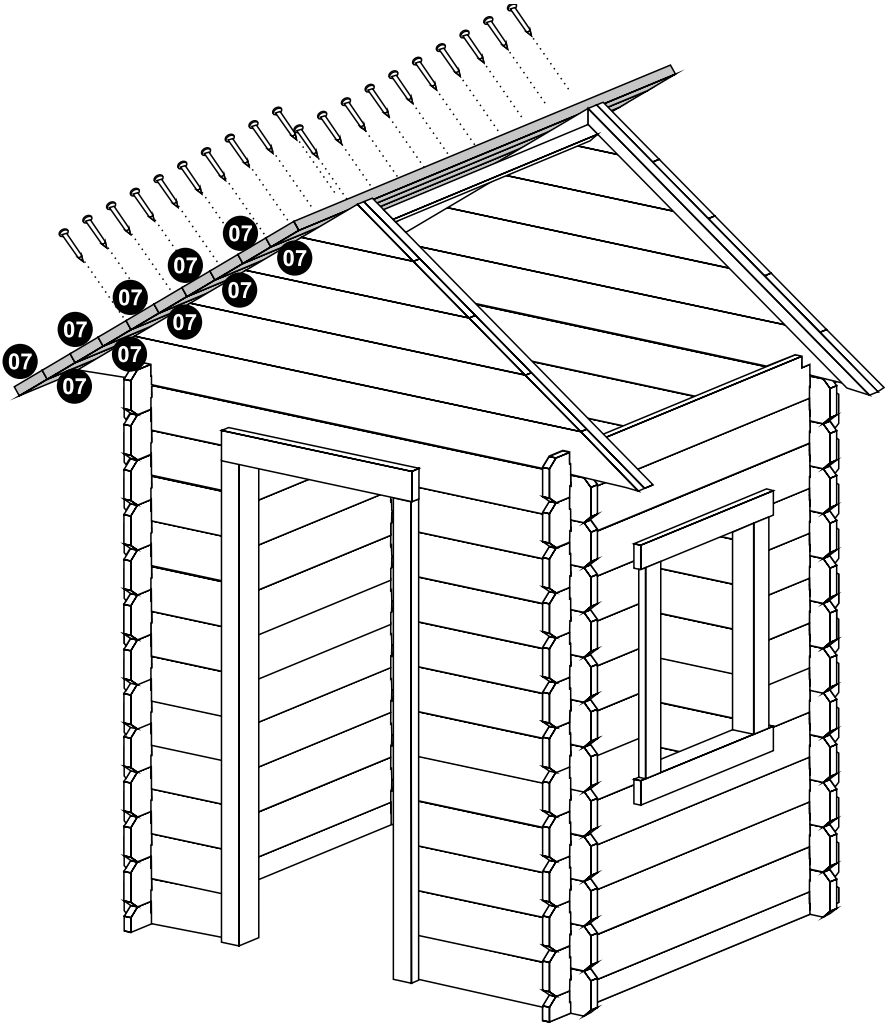

11

20 x  Z4

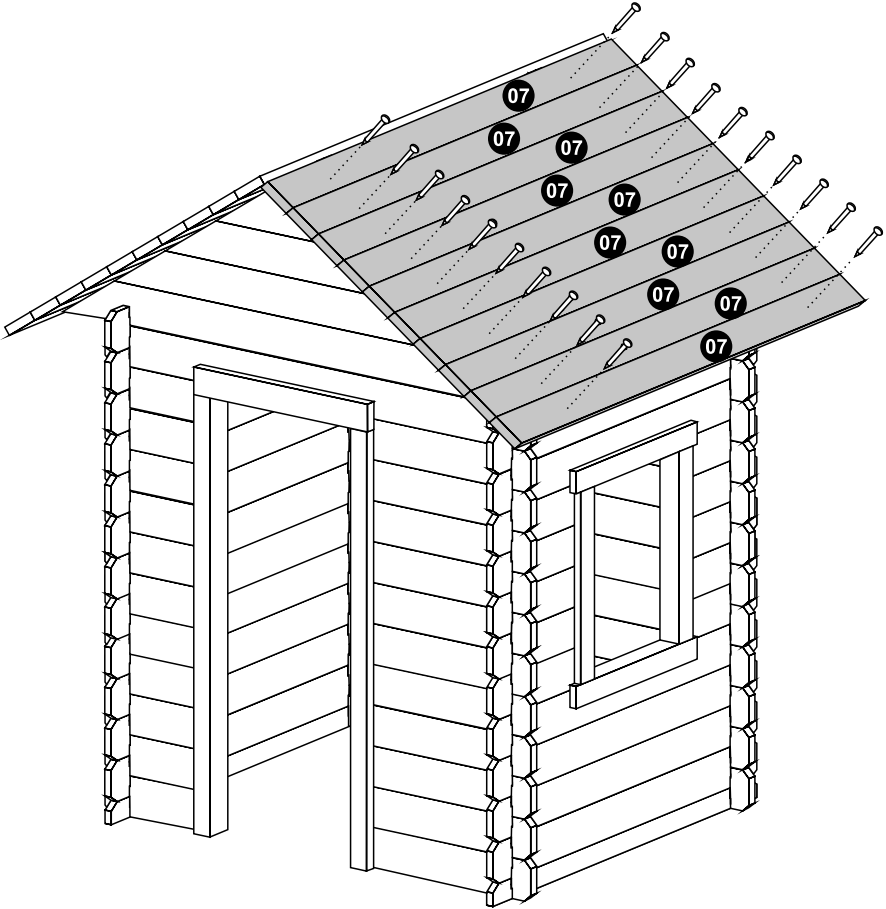



12

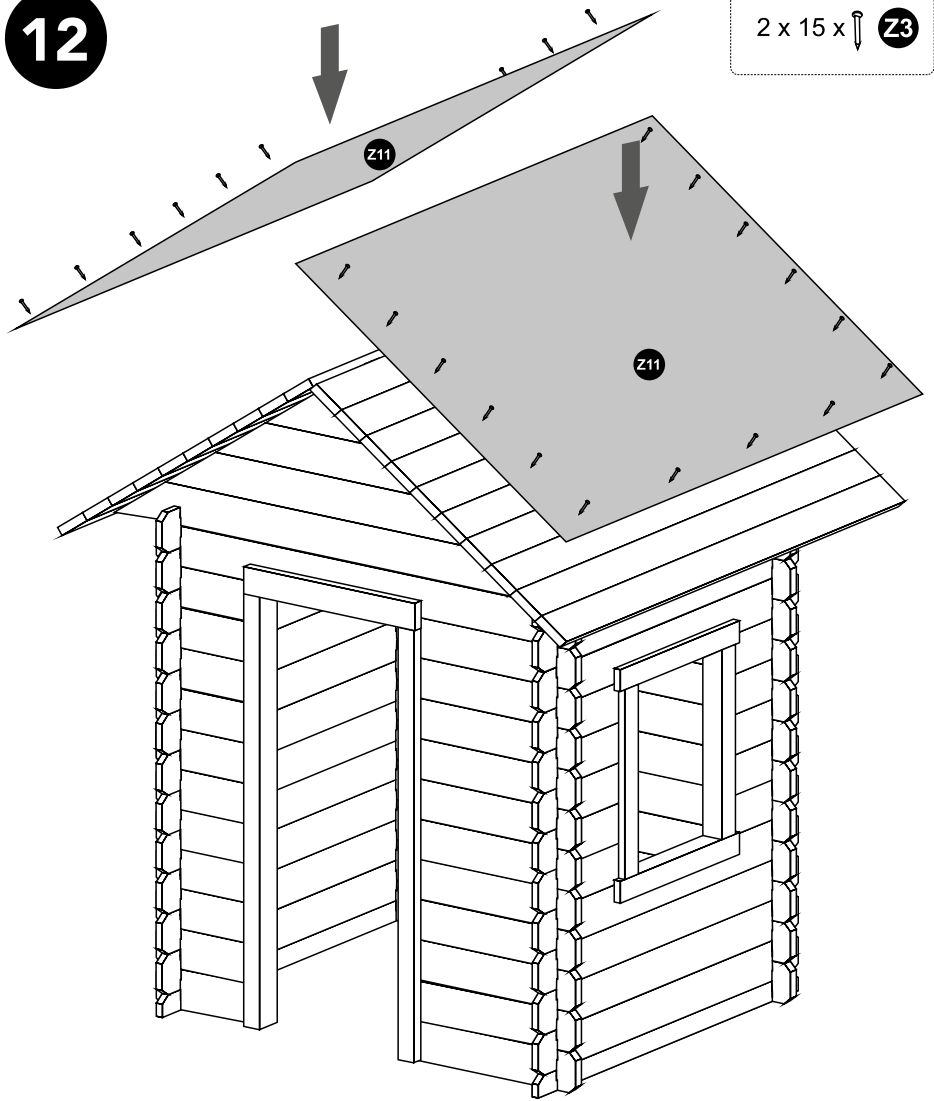

13

3 x  Z6

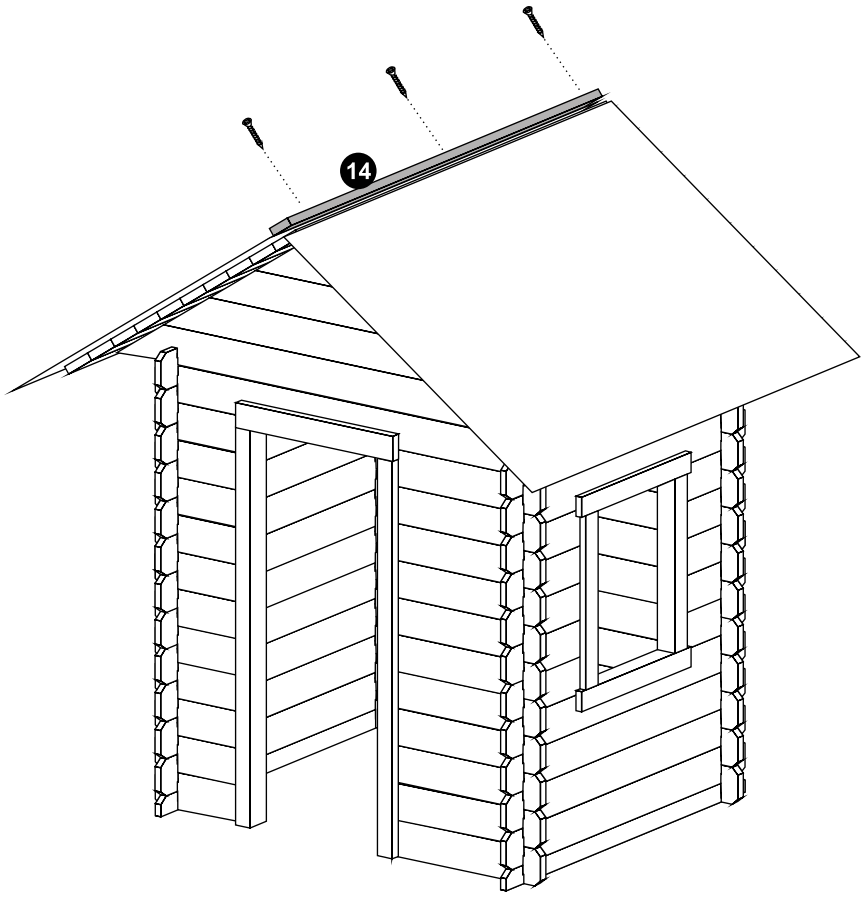

14

5 x  Z6

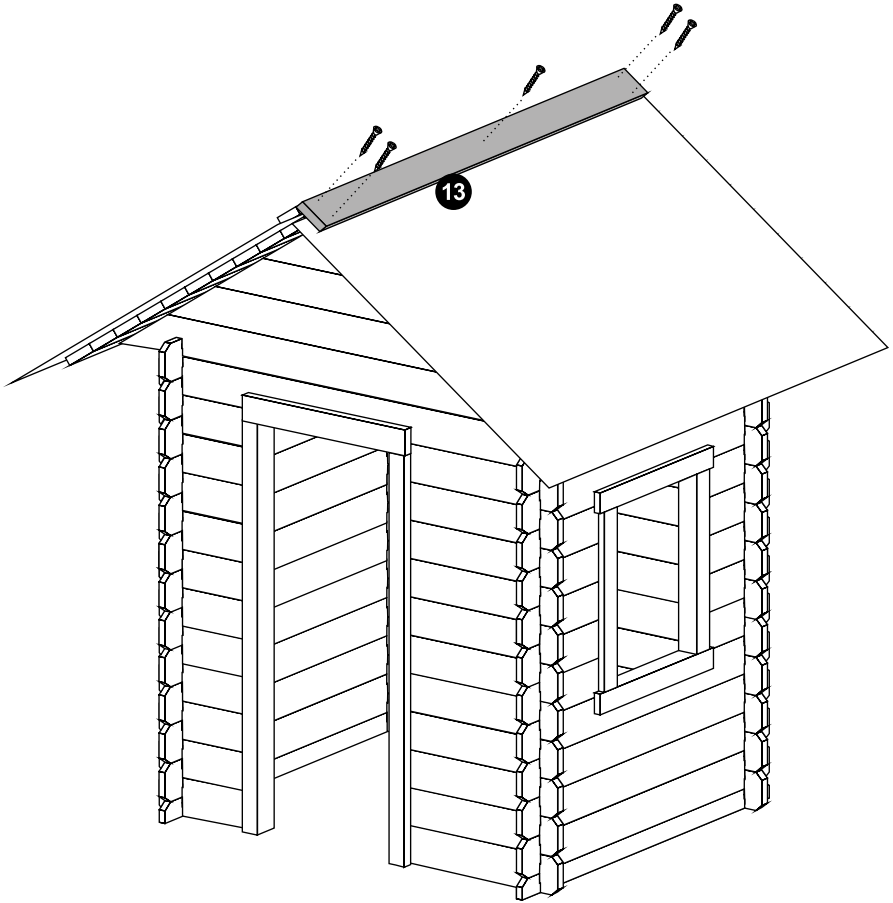

15

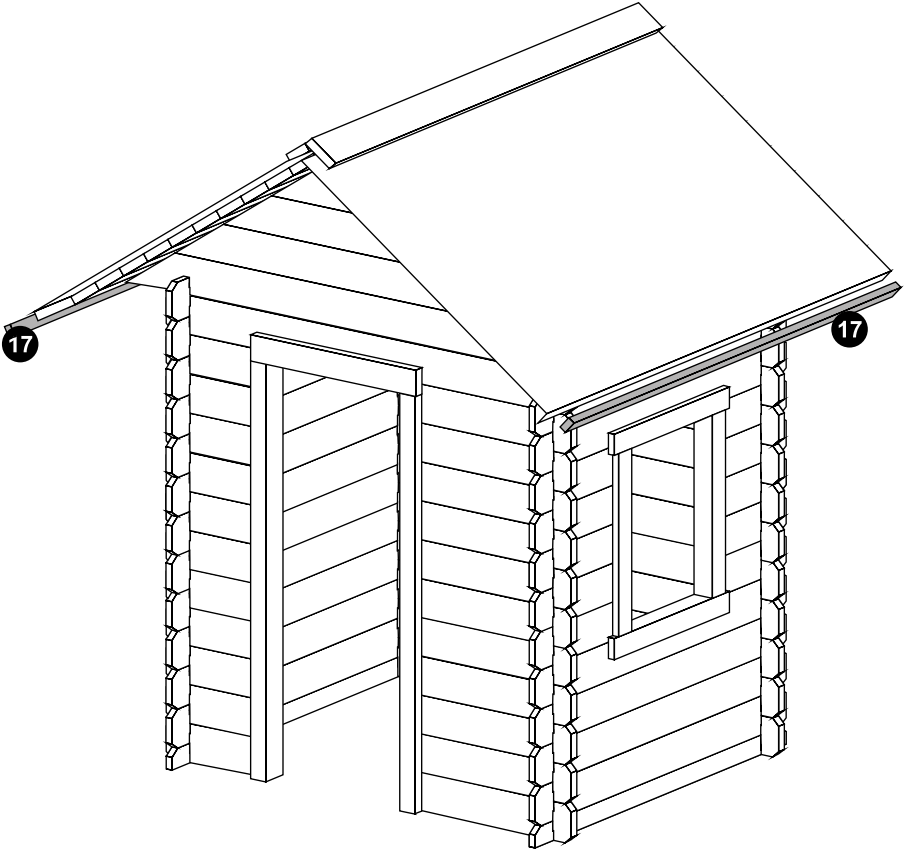

16

2 x 3 x  Z6

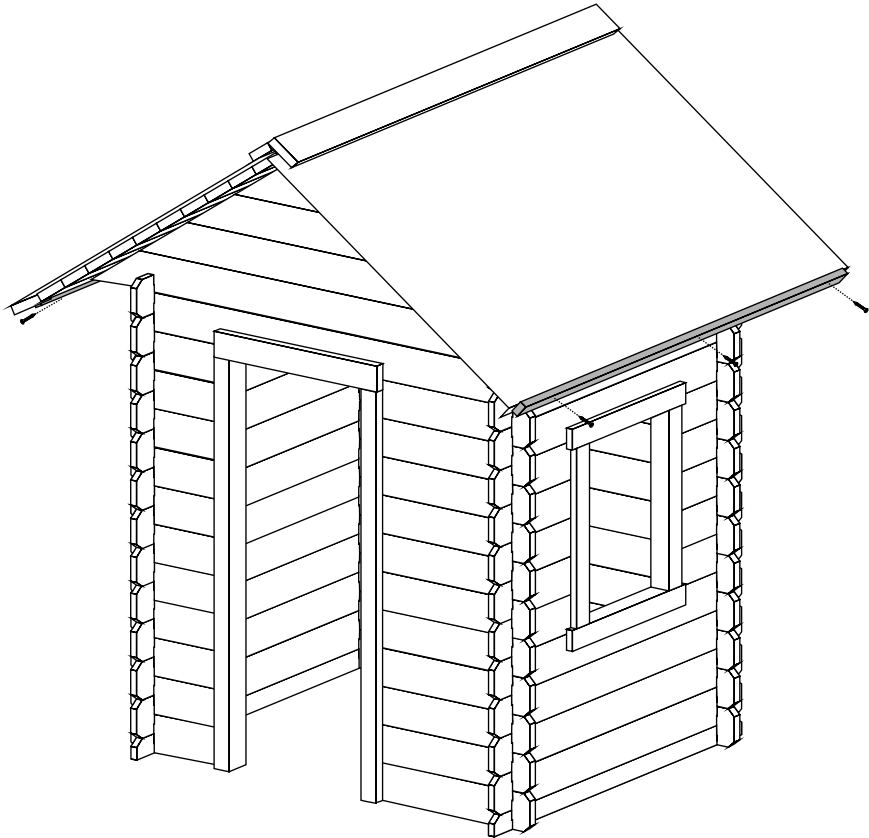

17

12 x  Z7

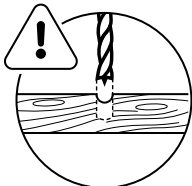
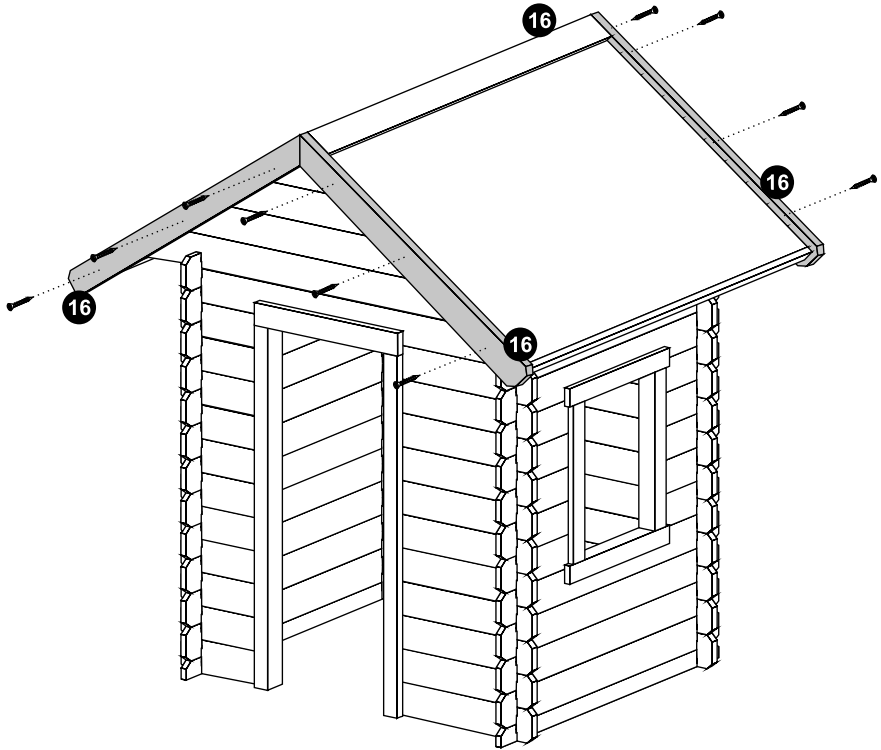

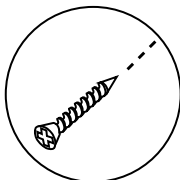

Ø 2,5 mm

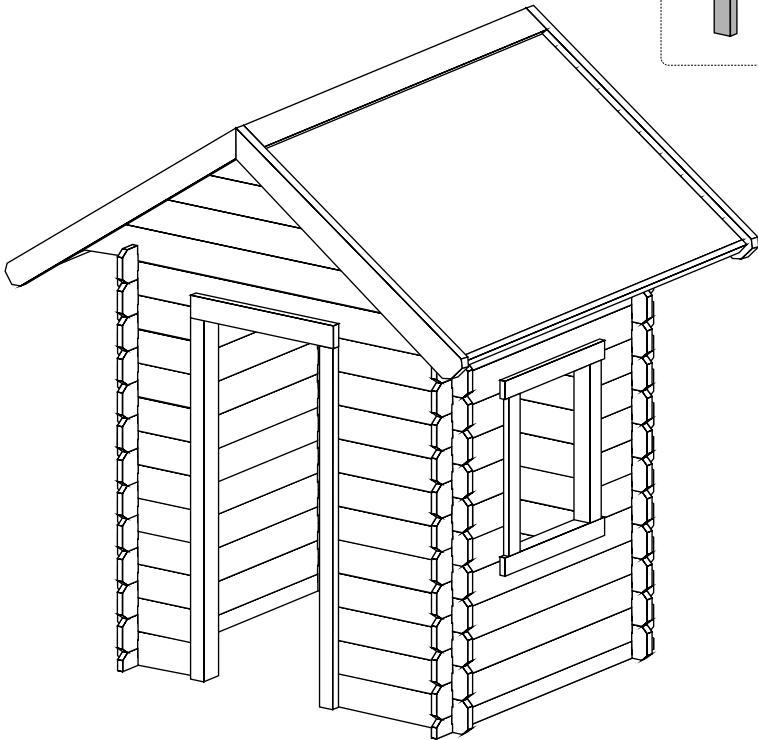
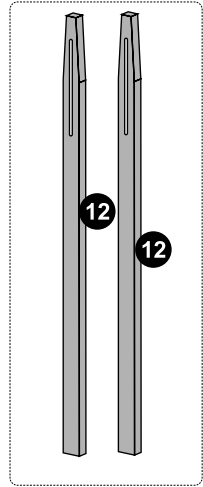

18



# 19

- 2 x  Z2
- 6 x  Z6

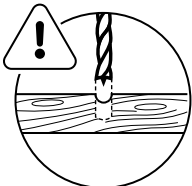
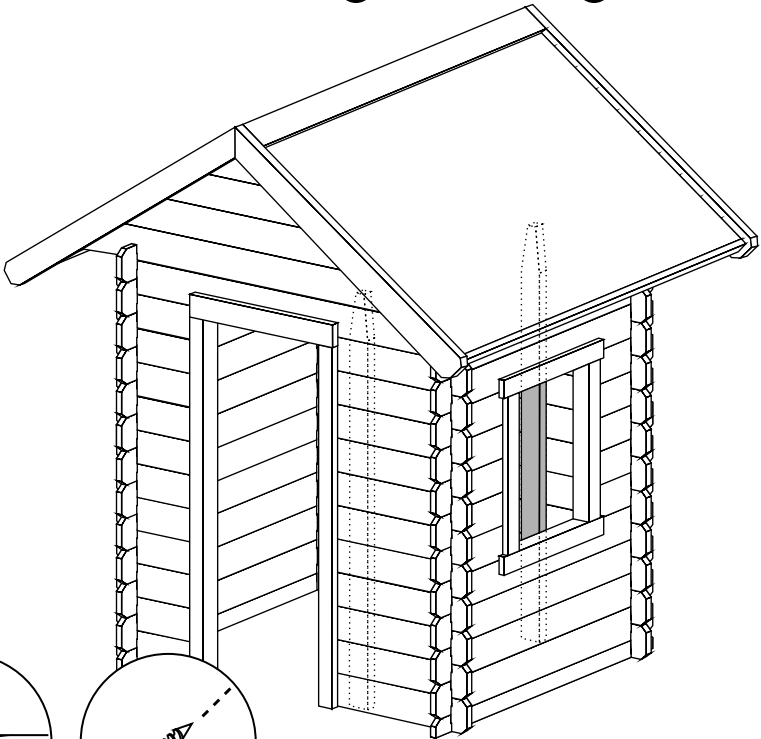
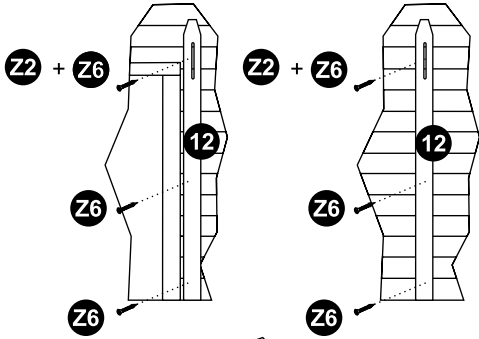
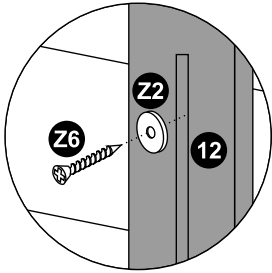

Ø 2,5 mm

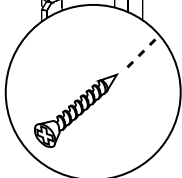



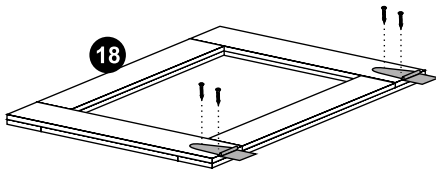
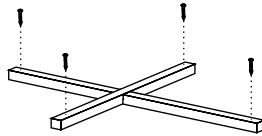
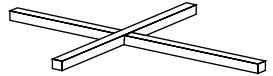
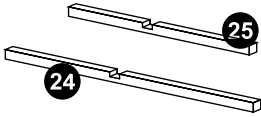

20

4 x  Z6



4 x  Z1  
8 x  Z5

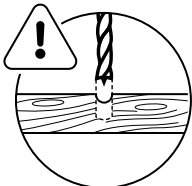

Ø 2,5 mm

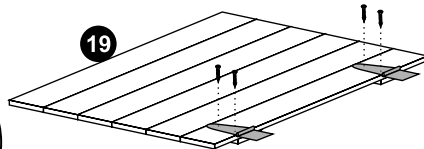
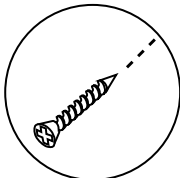

21

8 x  **Z7**

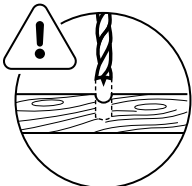
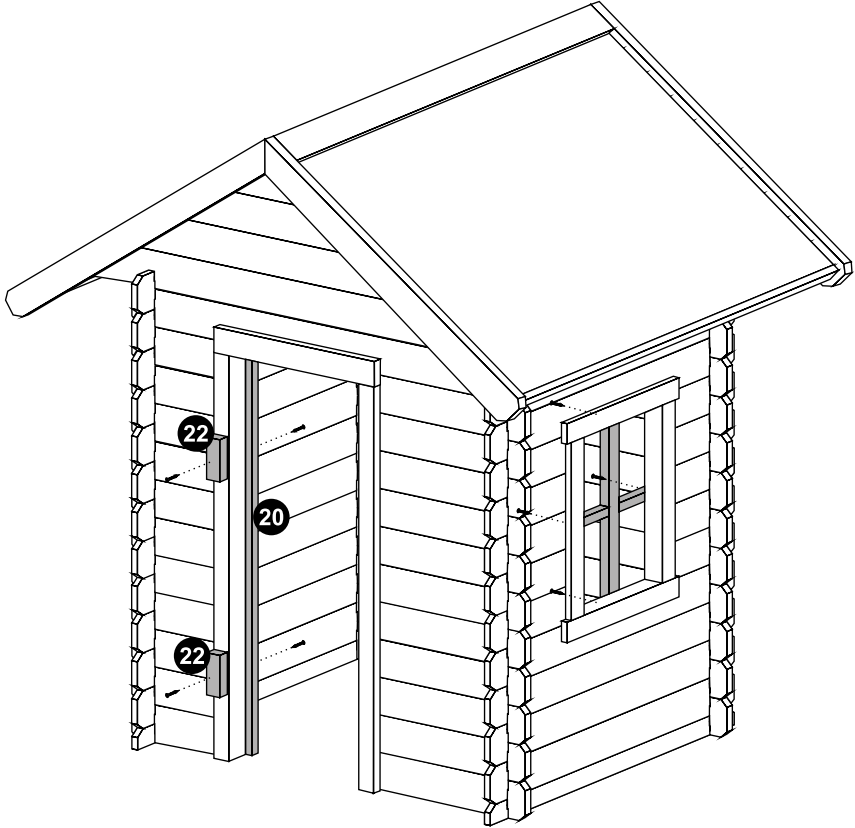

Ø 2,5 mm

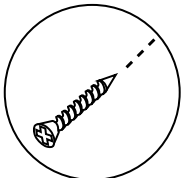

22

12 x  

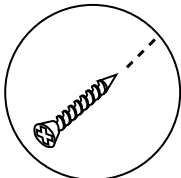
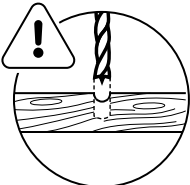
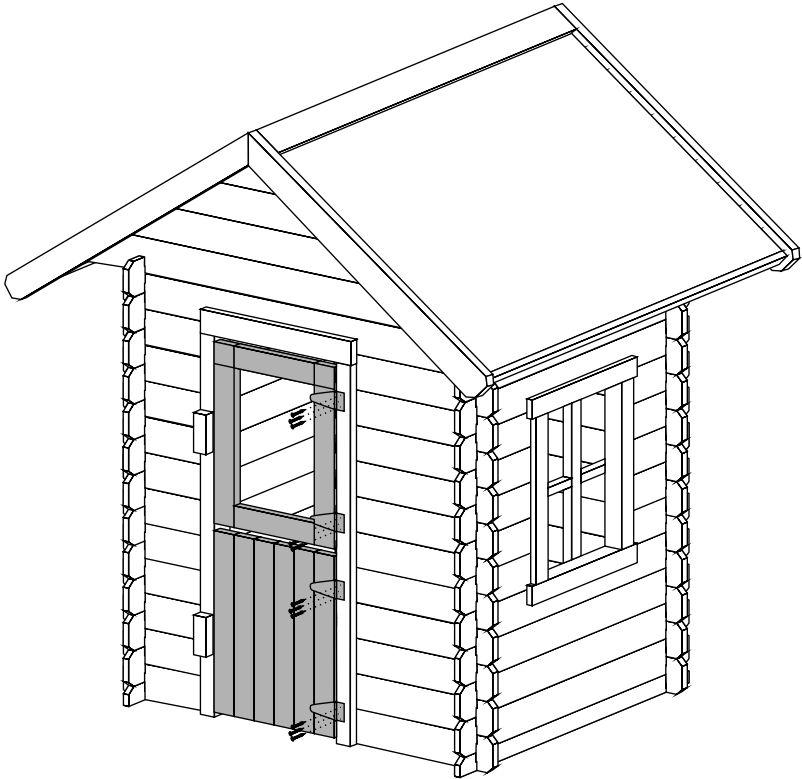

Ø 2,5 mm

23

4 x  **Z7**

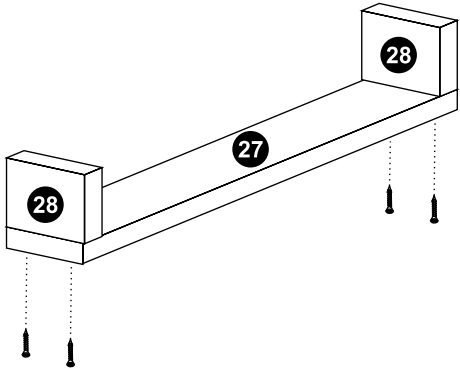

5 x  **Z7**

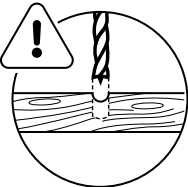
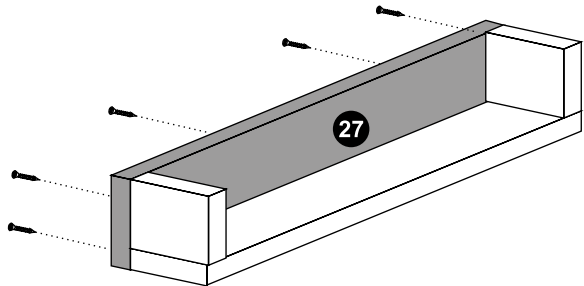

Ø 2,5 mm

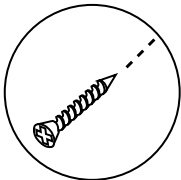

24

2 x  

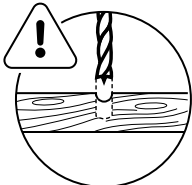
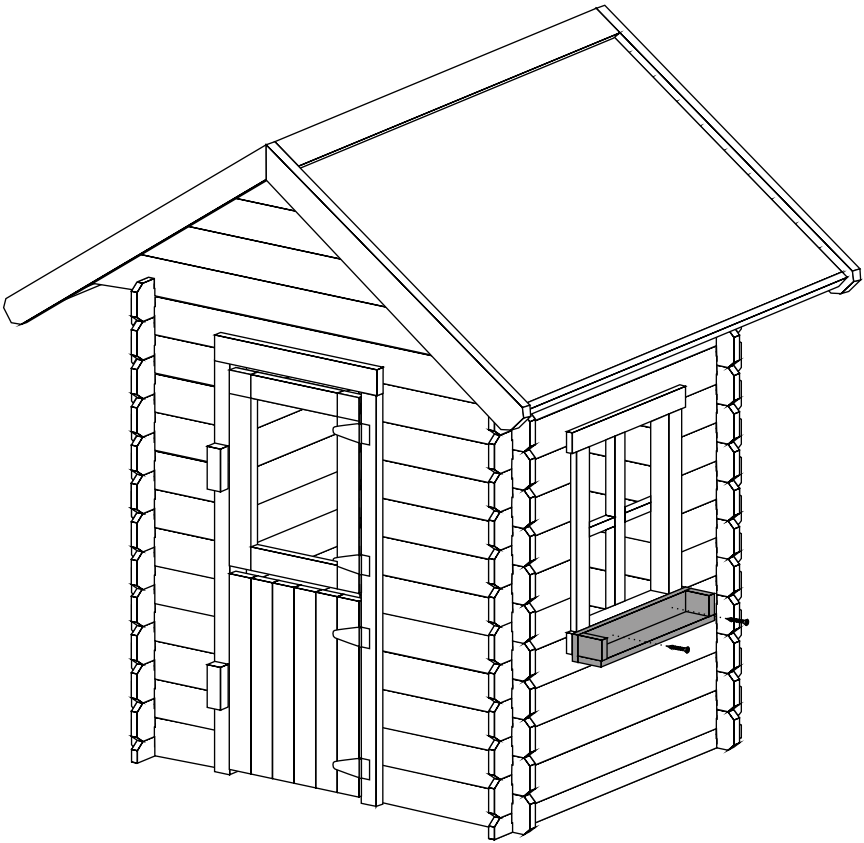

Ø 2,5 mm

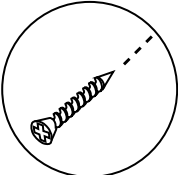

25

6 x  

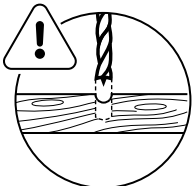
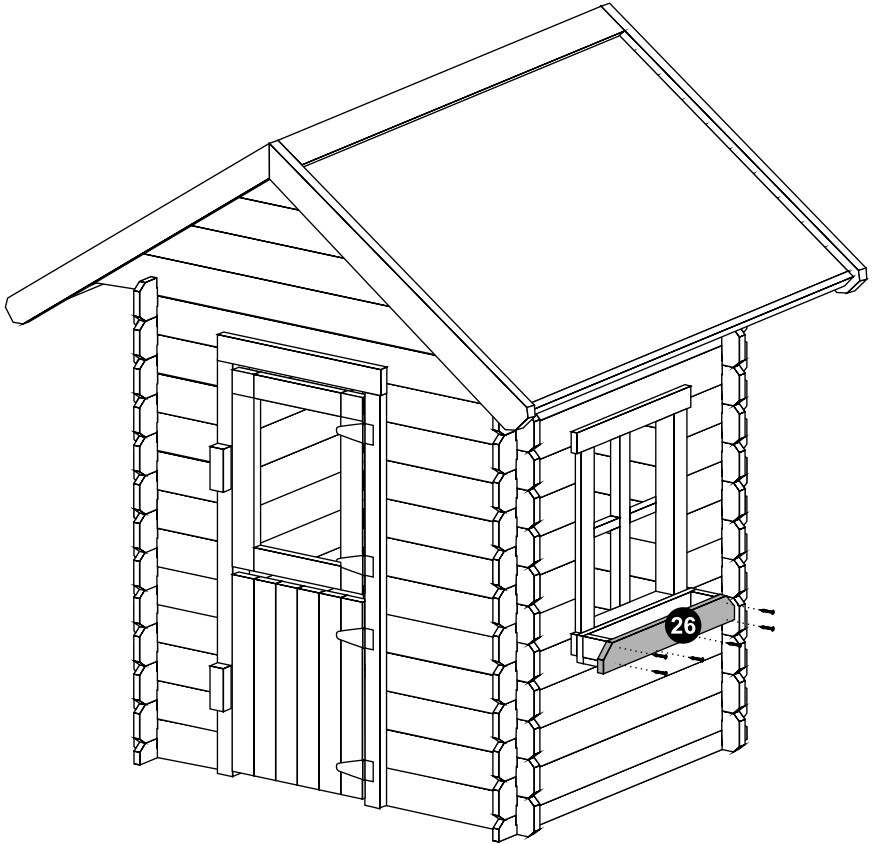

Ø 2,5 mm

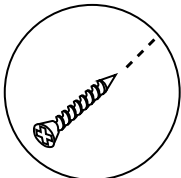





Scan for terms  
and conditions

+31(0)318 692 221  
[www.swingking.nl](http://www.swingking.nl)

Swing King IS A BRAND OF:

**HAPRO** INTERNATIONAL



8 717306 721738 >