

KUNSTSTOFF PLASTIQUE



WELLPLATTEN, FLACHPLATTEN
PLAQUES ONDULÉES, PLAQUES PLATES

DOPPEL- UND 3-STEGLATTEN
ÉLÉMENTS À DOUBLE ET TRIPLE PAROIS

PROFILE + BEFESTIGUNGSMATERIAL
PROFILÉS ET MATÉRIEL DE FIXATION



neogard
im Garten gut beraten

Die wichtigsten Informationen über Kunststoffe auf einen Blick!

Tableau synoptique des informations les plus importantes sur plastiques!



UV-aktives Material. Bedeutet u. a. auch gutes Gedeihen von Pflanzen!
Matière perméable aux rayons UV – c.-à.-d. favorable à la pousse des plantes.



UV-beständiges Material. Nichts versprödet, witterungsbeständig!
Matière résistante aux rayons UV. Pas de fragilité, résistante aux intempéries.



Thermoplaste nicht unter direkter Sonneneinstrahlung stapeln und lagern. Kann sofort zu Verformung und frühzeitiger Alterung führen.
Prière de ne pas stocker les matières thermoplastiques à une place directement ensoleillée afin d'éviter les déformations et le vieillissement prématuré.



Kunststoff lebt! Bei Montagen von Thermoplasten die Dilatation beachten. Dehnungen bis zu 3,5 mm pro m sind bei grösseren Temperaturunterschieden möglich.
En cas d'assez grandes différences de température il est possible que la matière se dilate jusqu'à 3,5 mm par mètre.



Material verträgt maximale Dauertemperaturen von bis zu 60°C. Unter 10°C wird das Material härter, ist schlagempfindlicher und mit grösserer Sorgfalt zu verarbeiten.
Matière résistante jusqu'à une température maximum de 60°C. En-dessous de 10°C, le matériel devient plus dur, résiste moins aux coups et doit être traité avec plus de soins.



Schlagzäher Kunststoff, wobei die Schlagfestigkeit bei niedrigen Temperaturen nachlässt.
Plastique d'une grande résilience diminuant aux températures basses.



Material kann mit handelsüblichen Bohrern bearbeitet werden.
Matière peut être traitée par perceuses d'usage.



Mit Silikon oder Klebstoffen klebbar und verbindbar. Bitte Anwenderhinweise beachten.
Assembler par substances adhésives ou bien silicone. Prière de consulter les informations pour utilisateurs.



Material mit Holzbearbeitungswerkzeug bearbeitbar.
Matière usinable par outils à travailler le bois.



Material mit einfachstem Holzbearbeitungswerkzeug bearbeitbar.
Matière usinable par outils à travailler le bois.



Zuschneiden mittels Trennscheibe möglich.
Couper par meules à tronçonner.



Material mit Eisenbearbeitungswerkzeug bearbeitbar.
Matière usinable par outils à travailler le fer.



Reinigung nur mit nicht aggressiven Reinigungsmitteln. Empfohlen wird handelsübliche Seifenlauge.
Prière de ne pas utiliser un détergent caustique. Nous vous recommandons une lessive d'usage.



Das Material ist kalt abbiegbar.
Matière peut être cintrée ou pliée à froid.



Recycling. Wiederverarbeitung von altem oder defektem Material möglich.
Recyclage – Retraitement de matière vieille ou bien endommagée possible.



Material nur mit zylindrisch zugeschnittenem Bohrer bearbeiten. In Randnähe besteht Ausreissgefahr.
Prière de travailler la matière seulement au moyen d'une perceuse cylindrique. Aux bords des laques risque de ruptures.

INHALT · SOMMAIRE

4

7

Polyesterplatten / *Plaques en polyester*

5

16

20

PVC

6

12–13

19

Acrylglas / *Verre acrylique*

8–10

Kunstglas / *Verre artificiel*

11

Plasticlair PET / *Plasticlair*

14–15

Hartschaumplatten / *Plaques expense*

17–18

Polycarbonat / *Polycarbonate*

21–28

31

Zubehör / *Accessoires*

29–30

Bitumen / *Bitumes*

POLYESTERPLATTEN PLAQUES EN POLYESTER

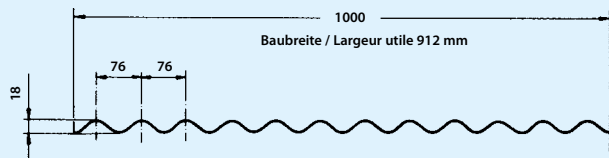

Polyesterplatten 76/18
Plaques en polyester 76/18 375 g

| Art.-Nr. No d'article | Farbe Couleur | Länge mm Longueur mm | Breite mm Largeur mm | Preis/Stk. Prix/pce |
|--------------------------|------------------|-------------------------|-------------------------|------------------------|
| 3000.045 | natur / nature | 1000 | 1000 | 13.50 |
| 3000.050 | natur / nature | 1500 | 1000 | 20.00 |
| 3000.055 | natur / nature | 2000 | 1000 | 26.00 |
| 3000.060 | natur / nature | 2500 | 1000 | 33.00 |
| 3000.064 | grün / vert | 1000 | 1000 | 13.50 |
| 3000.065 | grün / vert | 1500 | 1000 | 20.00 |
| 3000.070 | grün / vert | 2000 | 1000 | 26.00 |
| 3000.075 | grün / vert | 2500 | 1000 | 33.00 |
| 3000.079 | bronze | 1000 | 1000 | 13.50 |
| 3000.080 | bronze | 1500 | 1000 | 20.00 |
| 3000.085 | bronze | 2000 | 1000 | 26.00 |
| 3000.090 | bronze | 2500 | 1000 | 33.00 |



Polyesterplatten 95/37
Plaques en polyester 95/37

| Art.-Nr. No d'article | Farbe Couleur | Länge mm Longueur mm | Breite mm Largeur mm | Preis/Stk. Prix/pce |
|--------------------------|------------------|-------------------------|-------------------------|------------------------|
| 3150.080 | natur / nature | 2000 | 950 | 53.00 |



PVC

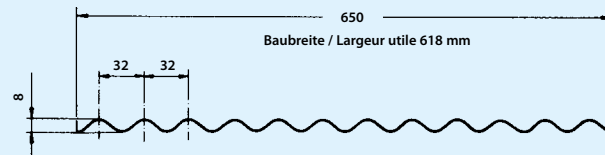

PVC-Platten Kleinwellung 8/32
Plaques PVC à petites ondes 8/32

| Art.-Nr. No d'article | Farbe Couleur | Länge mm Longueur mm | Breite mm Largeur mm | Preis/Stk. Prix/pce |
|--------------------------|------------------|-------------------------|-------------------------|------------------------|
| 3070.005 | glasklar / clair | 1000 | 650 | 9.00 |
| 3070.010 | grün / vert | 1000 | 650 | 9.00 |
| 3070.015 | azur / azuré | 1000 | 650 | 7.50 |

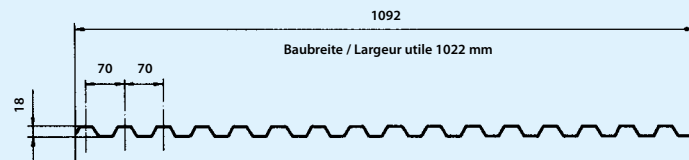

Spundwandprofilplatten PVC S 70/18
Plaques ondulés en PVC S 70/18

| Art.-Nr. No d'article | Farbe Couleur | Länge mm Longueur mm | Breite mm Largeur mm | Preis/Stk. Prix/pce |
|--------------------------|------------------------|-------------------------|-------------------------|------------------------|
| 3050.005 | glasklar / clair | 1500 | 1092 | 28.00 |
| 3050.010 | glasklar / clair | 2000 | 1092 | 38.00 |
| 3050.015 | glasklar / clair | 2500 | 1092 | 45.00 |
| 3050.020 | azur / azuré | 1500 | 1092 | 23.00 |
| 3050.025 | azur / azuré | 2000 | 1092 | 29.00 |
| 3050.030 | azur / azuré | 2500 | 1092 | 35.00 |
| 3050.035 | rauchbraun / brun fumé | 2500 | 1092 | 45.00 |

Wellplatten Prisma PVC S 76/18
Plaques ondulés prisme en PVC S 76/18

| Art.-Nr. No d'article | Farbe Couleur | Länge mm Longueur mm | Breite mm Largeur mm | Dicke mm Epaisseur mm | Preis/Stk. Prix/pce |
|--------------------------|------------------|-------------------------|-------------------------|--------------------------|------------------------|
| 3070.101 | bronze / bronze | 2000 | 1030 | 2.5 | 79.00 |



ACRYLGLAS · VERRE ACRYLIQUE

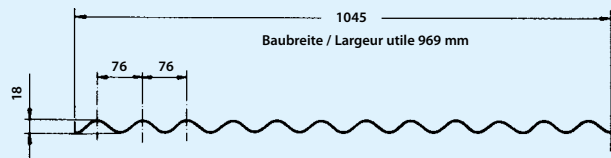

Acryl-Wellplatten «Wabe» 76/18, Stärke 3,0 mm
Plaques acryliques ondulé 76/18 structuré, Epaisseur 3,0 mm

| Art.-Nr. No d'article | Farbe Couleur | Länge mm Longueur mm | Breite mm Largeur mm | Preis/Stk. Prix/pce |
|--------------------------|------------------|-------------------------|-------------------------|------------------------|
| 3000.300 | klar / clair | 2000 | 1045 | 99.00 |
| 3000.305 | klar / clair | 2500 | 1045 | 129.00 |
| 3000.310 | klar / clair | 3000 | 1045 | 159.00 |
| 3000.319 | klar / clair | 4000 | 1045 | 209.00 |
| 3000.325 | klar / clair | 6000 | 1045 | 319.00 |
| 3000.301 | braun / brun | 2000 | 1045 | 99.00 |
| 3000.306 | braun / brun | 2500 | 1045 | 129.00 |
| 3000.311 | braun / brun | 3000 | 1045 | 159.00 |
| 3000.318 | braun / brun | 4000 | 1045 | 209.00 |
| 3000.326 | braun / brun | 6000 | 1045 | 319.00 |



Abbildung: Acryl-Wellplatte «Wabe» braun
Image: Plaque acrylique ondulé brun

POLYESTERPLATTEN PLAQUES EN POLYESTER

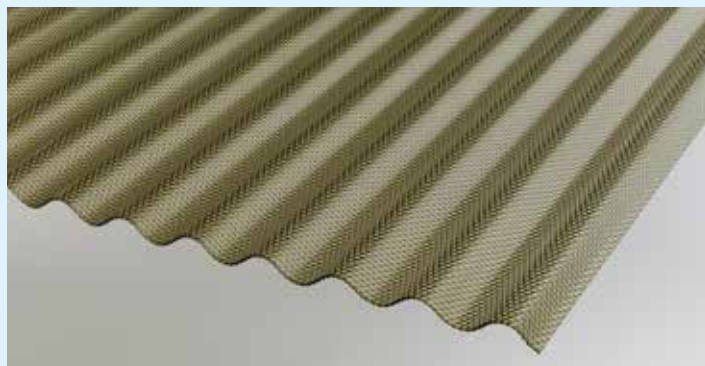
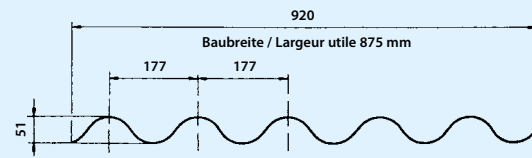

Polyesterplatten Eternitwellig 177/51
Plaques en polyester Ondulation Eternit 177/51 600 g

| Art.-Nr. No d'article | Farbe Couleur | Länge mm Longueur mm | Breite mm Largeur mm | Preis/Stk. Prix/pce |
|--------------------------|------------------|-------------------------|-------------------------|------------------------|
| 3000.041 | natur / nature | 2000 | 920 | 59.00 |
| 3000.047 | natur / nature | 2500 | 920 | 74.00 |

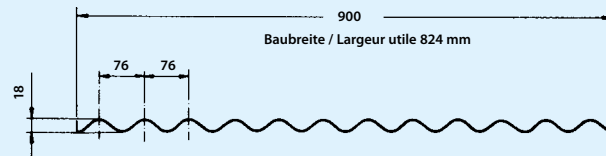
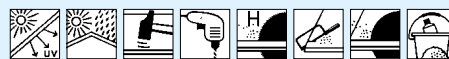

Poly-Clair Polyesterplatten 76/18, Qualität 690 g, beidseitig Gelcoat
Qualité 690 g, les 2 côtés Gelcoat

| Art.-Nr. No d'article | Farbe Couleur | Länge mm Longueur mm | Breite mm Largeur mm | Preis/Stk. Prix/pce |
|--------------------------|------------------|-------------------------|-------------------------|------------------------|
| 3000.150 | natur / nature | 1000 | 900 | 29.00 |
| 3000.155 | natur / nature | 1500 | 900 | 42.00 |
| 3000.160 | natur / nature | 2000 | 900 | 56.00 |
| 3000.165 | natur / nature | 2500 | 900 | 70.00 |
| 3000.170 | natur / nature | 3000 | 900 | 85.00 |
| 3000.175 | natur / nature | 3500 | 900 | 98.00 |
| 3000.180 | natur / nature | 4000 | 900 | 113.00 |
| 3000.185 | natur / nature | 5000 | 900 | 140.00 |
| 3000.190 | natur / nature | 6000 | 900 | 168.00 |



KUNSTGLAS · VERRE ARTIFICIEL

Kunstglas reflexfrei, 2 mm
verre artificiel antireflet, 2 mm

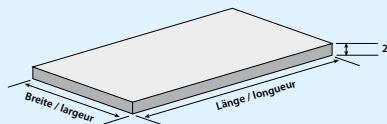

| Art.-Nr. No d'article | Farbe Couleur | Länge mm Longueur mm | Breite mm Largeur mm | Preis/Stk. Prix/pce |
|--------------------------|------------------------|-------------------------|-------------------------|------------------------|
| 3100.001 | glasklar / transparent | 180 | 130 | 2.50 |
| 3100.025 | glasklar / transparent | 180 | 240 | 3.50 |
| 3100.005 | glasklar / transparent | 240 | 300 | 4.50 |
| 3100.030 | glasklar / transparent | 300 | 400 | 7.00 |
| 3100.035 | glasklar / transparent | 400 | 500 | 11.00 |
| 3100.010 | glasklar / transparent | 480 | 600 | 14.00 |
| 3100.015 | glasklar / transparent | 500 | 700 | 16.00 |
| 3100.020 | glasklar / transparent | 1000 | 700 | 33.00 |



Kunstglas flach, 2,5 mm
Verre artificiel plat, 2,5 mm

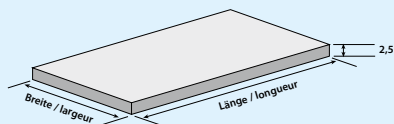

| Art.-Nr. No d'article | Farbe Couleur | Länge mm Longueur mm | Breite mm Largeur mm | Preis/Stk. Prix/pce |
|--------------------------|------------------|-------------------------|-------------------------|------------------------|
| 3120.015 | glasklar / clair | 500 | 1000 | 18.00 |
| 3120.010 | glasklar / clair | 1000 | 1000 | 35.00 |
| 3120.005 | glasklar / clair | 2000 | 1000 | 70.00 |
| 3120.094 | milch / opale | 500 | 1000 | 18.00 |
| 3120.095 | milch / opale | 1000 | 1000 | 35.00 |
| 3120.096 | milch / opale | 2000 | 1000 | 70.00 |



KUNSTGLAS · VERRE ARTIFICIEL

Kunstglas flach, 5,0 mm
Verre artificiel plat, 5,0 mm

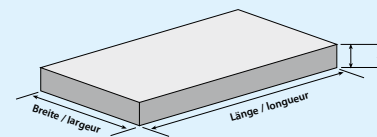

| Art.-Nr. No d'article | Farbe Couleur | Länge mm Longueur mm | Breite mm Largeur mm | Preis/Stk. Prix/pce |
|--------------------------|------------------|-------------------------|-------------------------|------------------------|
| 3120.030 | glasklar / clair | 500 | 1000 | 30.00 |
| 3120.025 | glasklar / clair | 1000 | 1000 | 60.00 |
| 3120.020 | glasklar / clair | 2000 | 1000 | 130.00 |
| 3120.027 | milch / opale | 500 | 1000 | 30.00 |
| 3120.028 | milch / opale | 1000 | 1000 | 60.00 |
| 3120.029 | milch / opale | 2000 | 1000 | 130.00 |



Kunstglas Tropfen, 5,0 mm
Verre artificiel «Tropfen», 5,0 mm

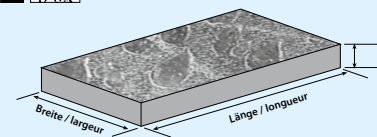

| Art.-Nr. No d'article | Farbe Couleur | Länge mm Longueur mm | Breite mm Largeur mm | Preis/Stk. Prix/pce |
|--------------------------|------------------|-------------------------|-------------------------|------------------------|
| 3119.990 | glasklar / clair | 500 | 1000 | 30.00 |
| 3119.980 | glasklar / clair | 1000 | 1000 | 60.00 |
| 3119.970 | glasklar / clair | 2000 | 1000 | 130.00 |



Kunstglas Tropfen, 2,5 mm
Verre artificiel «Tropfen», 2,5 mm

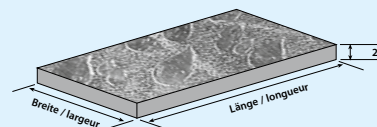

| Art.-Nr. No d'article | Farbe Couleur | Länge mm Longueur mm | Breite mm Largeur mm | Preis/Stk. Prix/pce |
|--------------------------|------------------|-------------------------|-------------------------|------------------------|
| 3120.018 | glasklar / clair | 500 | 1000 | 18.00 |
| 3120.012 | glasklar / clair | 1000 | 1000 | 35.00 |
| 3120.007 | glasklar / clair | 2000 | 1000 | 70.00 |



KUNSTGLAS · VERRE ARTIFICIEL

Kunstglas strukturiert, 2,5 mm
Verre artificiel structuré, 2,5 mm

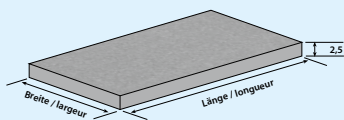

| Art.-Nr. No d'article | Farbe Couleur | Länge mm Longueur mm | Breite mm Largeur mm | Preis/Stk. Prix/pce |
|--------------------------|------------------|-------------------------|-------------------------|------------------------|
| 3120.060 | glasklar / clair | 500 | 1000 | 18.00 |
| 3120.055 | glasklar / clair | 1000 | 1000 | 35.00 |
| 3120.050 | glasklar / clair | 2000 | 1000 | 70.00 |



Kunstglas Baumrinde, 5,0 mm
Verre artificiel écorce d'arbre, 5,0 mm

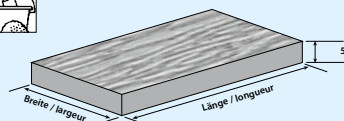

| Art.-Nr. No d'article | Farbe Couleur | Länge mm Longueur mm | Breite mm Largeur mm | Preis/Stk. Prix/pce |
|--------------------------|------------------|-------------------------|-------------------------|------------------------|
| 3120.032 | braun / brun | 500 | 1000 | 30.00 |
| 3120.033 | braun / brun | 1000 | 1000 | 60.00 |
| 3120.034 | braun / brun | 2000 | 1000 | 130.00 |
| 3120.047 | glasklar / clair | 500 | 1000 | 30.00 |
| 3120.048 | glasklar / clair | 1000 | 1000 | 60.00 |
| 3120.049 | glasklar / clair | 2000 | 1000 | 130.00 |



Kunstglas Baumrinde, 2,5 mm
Verre artificiel écorce d'arbre, 2,5 mm

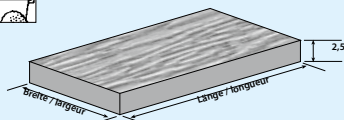

| Art.-Nr. No d'article | Farbe Couleur | Länge mm Longueur mm | Breite mm Largeur mm | Preis/Stk. Prix/pce |
|--------------------------|------------------|-------------------------|-------------------------|------------------------|
| 3120.077 | glasklar / clair | 500 | 1000 | 18.00 |
| 3120.078 | glasklar / clair | 1000 | 1000 | 35.00 |
| 3120.079 | glasklar / clair | 2000 | 1000 | 70.00 |
| 3120.091 | braun / brun | 500 | 1000 | 18.00 |
| 3120.092 | braun / brun | 1000 | 1000 | 35.00 |
| 3120.093 | braun / brun | 2000 | 1000 | 70.00 |



PLASTICLAIR PET · PLASTICLAIR

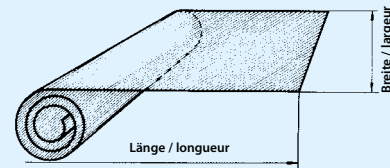

Plasticlair 0,7 mm glasklar, in Rollen, PET
Plasticlair 0,7 mm transparent, en rouleaux, PET

| Art.-Nr. No d'article | Farbe Couleur | Länge m Longueur m | Breite m Largeur m | Preis/m Prix/m |
|--------------------------|------------------|-----------------------|-----------------------|-------------------|
| 3060.006 | natur / nature | 47,00 | 1,00 | 14.50 |
| 3060.011 | natur / nature | 47,00 | 1,25 | 18.00 |



Abbildung: Plasticlair-Rolle
Image: Plasticlair en rouleau

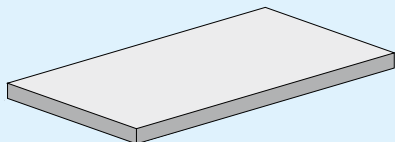

Acryl-Glas extrudiert, flach
Verre acrylique – qualité extrudé

| Art.-Nr. No d'article | Farbe Couleur | Dicke mm Epaisseur mm | Masse mm Mesures mm | Preis/Stk. Prix/pce |
|--------------------------|------------------|--------------------------|------------------------|------------------------|
| 3110.005 | glasklar / clair | 2 | 250 × 500 | 7.50 |
| 3110.010 | glasklar / clair | 2 | 500 × 500 | 15.00 |
| 3110.020 | glasklar / clair | 2 | 750 × 500 | 23.00 |
| 3111.041 | glasklar / clair | 2 | 3050 × 2050 | 219.00 |
| 3110.021 | glasklar / clair | 2 | Zuschnitt / Coupe | 70.00 / m ² |
| 3110.025 | glasklar / clair | 3 | 250 × 500 | 9.00 |
| 3110.030 | glasklar / clair | 3 | 500 × 500 | 18.50 |
| 3110.035 | glasklar / clair | 3 | 750 × 500 | 27.00 |
| 3110.040 | glasklar / clair | 3 | 1000 × 500 | 35.00 |
| 3110.045 | glasklar / clair | 3 | 1250 × 500 | 45.00 |
| 3110.046 | glasklar / clair | 3 | 1500 × 500 | 56.00 |
| 3110.047 | glasklar / clair | 3 | 1000 × 745 | 56.00 |
| 3110.050 | glasklar / clair | 3 | 1500 × 745 | 77.00 |
| 3111.043 | glasklar / clair | 3 | 3050 × 2050 | 319.00 |
| 3110.051 | glasklar / clair | 3 | Zuschnitt / Coupe | 85.00 / m ² |

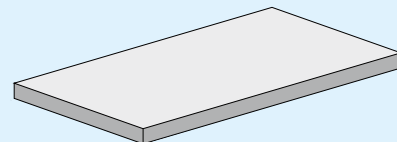

Acryl-Glas extrudiert, flach
Verre acrylique – qualité extrudé

| Art.-Nr. No d'article | Farbe Couleur | Dicke mm Epaisseur mm | Masse mm Mesures mm | Preis/Stk. Prix/pce |
|--------------------------|------------------|--------------------------|------------------------|-------------------------|
| 3111.044 | glasklar / clair | 4 | 3050 × 2050 | 429.00 |
| 3111.054 | glasklar / clair | 4 | Zuschnitt / Coupe | 99.00 / m ² |
| 3110.055 | glasklar / clair | 5 | 250 × 500 | 13.00 |
| 3110.060 | glasklar / clair | 5 | 500 × 500 | 26.00 |
| 3110.065 | glasklar / clair | 5 | 750 × 500 | 39.00 |
| 3110.070 | glasklar / clair | 5 | 1000 × 500 | 52.00 |
| 3110.075 | glasklar / clair | 5 | 1250 × 500 | 67.00 |
| 3110.079 | glasklar / clair | 5 | 1000 × 745 | 75.00 |
| 3110.076 | glasklar / clair | 5 | 1500 × 500 | 75.00 |
| 3110.080 | glasklar / clair | 5 | 1500 × 745 | 115.00 |
| 3111.045 | glasklar / clair | 5 | 3050 × 2050 | 519.00 |
| 3110.081 | glasklar / clair | 5 | Zuschnitt / Coupe | 109.00 / m ² |
| 3111.046 | glasklar / clair | 6 | 3050 × 2050 | 629.00 |
| 3111.056 | glasklar / clair | 6 | Zuschnitt / Coupe | 129.00 / m ² |
| 3111.048 | glasklar / clair | 8 | 3050 × 2050 | 680.00 |
| 3111.049 | glasklar / clair | 8 | Zuschnitt / Coupe | 159.00 / m ² |
| 3111.070 | glasklar / clair | 10 | 3050 × 2050 | 880.00 |
| 3111.071 | glasklar / clair | 10 | Zuschnitt / Coupe | 199.00 / m ² |



HARTSCHAUMPLATTEN PLAQUES EXPENSE

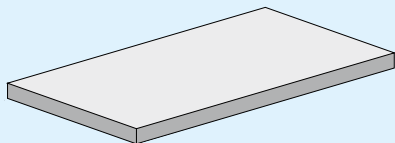

PVC-Hartschaumplatten
Plaques expense en PVC

| Art.-Nr. No d'article | Farbe Couleur | Dicke mm Epaisseur mm | Masse mm Mesures mm | Preis/Stk. Prix/pce |
|--------------------------|------------------|--------------------------|------------------------|------------------------|
| 3080.200 | gelb /jaune | 3 | 500 × 250 | 4.50 |
| 3080.202 | gelb /jaune | 3 | 500 × 500 | 8.50 |
| 3080.204 | gelb /jaune | 3 | 500 × 1000 | 15.50 |
| 3080.206 | gelb /jaune | 3 | 500 × 1250 | 18.50 |
| 3080.208 | gelb /jaune | 3 | 500 × 1500 | 23.50 |
| 3080.210 | grün /vert | 3 | 500 × 250 | 4.50 |
| 3080.212 | grün /vert | 3 | 500 × 500 | 8.50 |
| 3080.214 | grün /vert | 3 | 500 × 1000 | 15.50 |
| 3080.216 | grün /vert | 3 | 500 × 1250 | 18.50 |
| 3080.218 | grün /vert | 3 | 500 × 1500 | 23.50 |
| 3080.220 | blau /bleu | 3 | 500 × 250 | 4.50 |
| 3080.222 | blau /bleu | 3 | 500 × 500 | 8.50 |
| 3080.224 | blau /bleu | 3 | 500 × 1000 | 15.50 |
| 3080.226 | blau /bleu | 3 | 500 × 1250 | 18.50 |
| 3080.228 | blau /bleu | 3 | 500 × 1500 | 23.50 |
| 3080.230 | rot /rouge | 3 | 500 × 250 | 4.50 |
| 3080.232 | rot /rouge | 3 | 500 × 500 | 8.50 |
| 3080.234 | rot /rouge | 3 | 500 × 1000 | 15.50 |
| 3080.236 | rot /rouge | 3 | 500 × 1250 | 18.50 |
| 3080.238 | rot /rouge | 3 | 500 × 1500 | 23.50 |



HARTSCHAUMPLATTEN PLAQUES EXPENSE

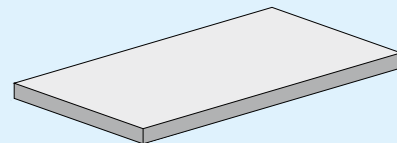

PVC-Hartschaumplatten
Plaques expense en PVC

| Art.-Nr. No d'article | Farbe Couleur | Dicke mm Epaisseur mm | Masse mm Mesures mm | Preis/Stk. Prix/pce |
|--------------------------|------------------|--------------------------|------------------------|------------------------|
| 3080.240 | weiss /blanc | 3 | 500 × 250 | 4.50 |
| 3080.242 | weiss /blanc | 3 | 500 × 500 | 8.50 |
| 3080.244 | weiss /blanc | 3 | 500 × 1000 | 15.50 |
| 3080.246 | weiss /blanc | 3 | 500 × 1250 | 18.50 |
| 3080.248 | weiss /blanc | 3 | 500 × 1500 | 23.50 |
| 3080.250 | grau /gris | 3 | 500 × 250 | 4.50 |
| 3080.252 | grau /gris | 3 | 500 × 500 | 8.50 |
| 3080.254 | grau /gris | 3 | 500 × 1000 | 15.50 |
| 3080.256 | grau /gris | 3 | 500 × 1250 | 18.50 |
| 3080.258 | grau /gris | 3 | 500 × 1500 | 23.50 |
| 3080.260 | schwarz /noir | 3 | 500 × 250 | 4.50 |
| 3080.262 | schwarz /noir | 3 | 500 × 500 | 8.50 |
| 3080.264 | schwarz /noir | 3 | 500 × 1000 | 15.50 |
| 3080.266 | schwarz /noir | 3 | 500 × 1250 | 18.50 |
| 3080.268 | schwarz /noir | 3 | 500 × 1500 | 23.50 |



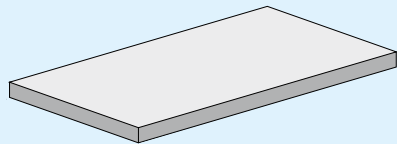

PVC-Flachplatten opak geschäumt
Plaques opaques en PVC

| Art.-Nr. No d'article | Farbe Couleur | Dicke mm Epaisseur mm | Masse mm Mesures mm | Preis/Stk. Prix/pce |
|--------------------------|------------------|--------------------------|------------------------|------------------------|
| 3080.005 | weiss / blanc | 4 | 600 × 1000 | 28.00 |
| 3080.010 | weiss / blanc | 4 | 1200 × 1000 | 55.00 |
| 3080.015 | grau / gris | 4 | 600 × 1000 | 28.00 |
| 3080.020 | grau / gris | 4 | 1200 × 1000 | 55.00 |
| 3080.090 | weiss / blanc | 10 | 600 × 1000 | 55.00 |
| 3080.095 | weiss / blanc | 10 | 1200 × 1000 | 105.00 |

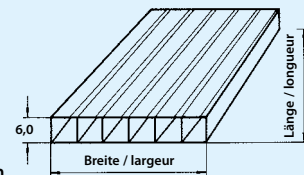

Polycarbonat-Doppelstegplatten glasklar, 6 mm
Plaques doubles à alvéoles, transparent, 6 mm

| Art.-Nr. No d'article | Farbe Couleur | Länge mm Longueur mm | Breite mm Largeur mm | Preis/Stk. Prix/pce |
|--------------------------|------------------------|-------------------------|-------------------------|------------------------|
| 0717.110 | glasklar / transparent | 1250 | 730 | 35.00 |
| 0717.100 | glasklar / transparent | 1650 | 730 | 45.00 |
| 3200.040 | glasklar / transparent | 750 | 1050 | 25.00 |
| 3200.034 | glasklar / transparent | 1500 | 1050 | 48.00 |
| 3200.033 | glasklar / transparent | 2000 | 1050 | 69.00 |
| 3200.031 | glasklar / transparent | 2500 | 1050 | 89.00 |
| 3200.015 | glasklar / transparent | 1000 | 2100 | 78.00 |
| 3200.012 | glasklar / transparent | 2000 | 2100 | 139.00 |
| 3200.005 | glasklar / transparent | 6000 | 2100 | 419.00 |



Polycarbonat Doppelstegplatten
glasklar, 10 mm
Plaques doubles à alvéoles, transparent, 10 mm

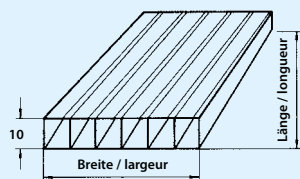

| Art.-Nr. No d'article | Farbe Couleur | Länge mm Longueur mm | Breite mm Largeur mm | Preis/Stk. Prix/pce |
|--------------------------|------------------------|-------------------------|-------------------------|------------------------|
| 3200.053 | glasklar / transparent | 2000 | 2100 | 210.00 |
| 3200.050 | glasklar / transparent | 3000 | 2100 | 310.00 |
| 3200.045 | glasklar / transparent | 6000 | 2100 | 610.00 |

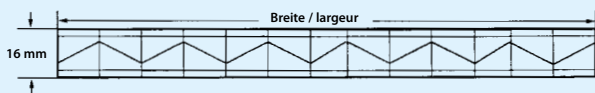

Polycarbonat 7-fach, glasklar, 16 mm, UV-vergütet
Plaques structure 7-fois, transparent, 16 mm, avec protection UV

| Art.-Nr. No d'article | Farbe Couleur | Länge mm Longueur mm | Breite mm Largeur mm | Preis/Stk. Prix/pce |
|--------------------------|------------------------|-------------------------|-------------------------|------------------------|
| 3200.213 | glasklar / transparent | 2000 | 2100 | 295.00 |
| 3200.210 | glasklar / transparent | 3000 | 2100 | 450.00 |
| 3200.205 | glasklar / transparent | 6000 | 2100 | 890.00 |

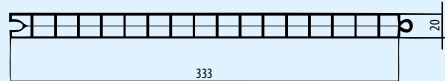

Polycarbonat 3-Stegelemente 330/20
Éléments à triple parois en polycarbonat 330/20

| Art.-Nr. No d'article | Farbe Couleur | Länge mm Longueur mm | Breite mm Largeur mm | Preis/Stk. Prix/pce |
|--------------------------|------------------------|-------------------------|-------------------------|------------------------|
| 3170.146 | glasklar / transparent | 1500 | 333 | 53.00 |
| 3170.147 | glasklar / transparent | 2000 | 333 | 72.00 |
| 3170.148 | glasklar / transparent | 3000 | 333 | 108.00 |

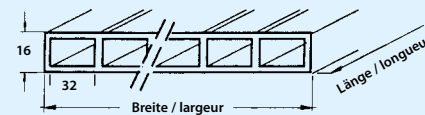

Stegdoppelplatte Plexiglas
16 / 32 / 980
Plaques acryliques Plexiglas
16 / 32 / 980

| Art.-Nr. No d'article | Farbe Couleur | Länge mm Longueur mm | Breite mm Largeur mm | Preis/Stk. Prix/pce |
|--------------------------|------------------|-------------------------|-------------------------|------------------------|
| 3300.005 | glasklar / clair | 1500 | 980 | 140.00 |
| 3300.010 | glasklar / clair | 2000 | 980 | 190.00 |
| 3300.020 | glasklar / clair | 3000 | 980 | 270.00 |



Abbildung: Stegdoppelplatte Plexiglas 16/32/980
Image: Plaque acrylique Plexiglas 16/32/980



Abbildung: Polycarbonat 3-Stegelemente 330/20
Image: Éléments à triple parois en polycarbonat 330/20

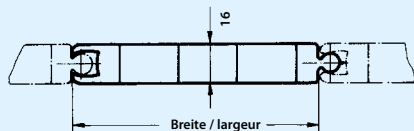



PVC-Doppelwandelemente Nut + Kamm 200/16, transparent
Éléments à double parois en PVC 200/16, transparent, avec rainure et crête



| Art.-Nr. No d'article | Farbe Couleur | Länge mm Longueur mm | Breite mm Largeur mm | Preis/Stk. Prix/pce |
|--------------------------|------------------------|-------------------------|-------------------------|------------------------|
| 3160.006 | natur / nature | 1500 | 200 | 11.95 |
| 3160.007 | natur / nature | 2000 | 200 | 15.95 |
| 3160.008 | natur / nature | 2500 | 200 | 19.95 |
| 3160.005 | azur / azuré | 1500 | 200 | 10.50 |
| 3160.010 | azur / azuré | 2000 | 200 | 13.50 |
| 3160.015 | azur / azuré | 2500 | 200 | 17.00 |
| 3160.025 | rauchbraun / brun fumé | 1500 | 200 | 10.50 |
| 3160.030 | rauchbraun / brun fumé | 2000 | 200 | 13.50 |
| 3160.035 | rauchbraun / brun fumé | 2500 | 200 | 17.00 |
| 3160.041 | grün / vert | 1500 | 200 | 15.95 |
| 3160.042 | grün / vert | 2000 | 200 | 19.95 |
| 3160.043 | grün / vert | 2500 | 200 | 24.90 |
| 3160.048 | orange / orange | 2500 | 200 | 24.90 |
| 3160.047 | orange / orange | 2000 | 200 | 19.95 |
| 3160.046 | orange / orange | 1500 | 200 | 15.95 |



Profil für Flachplatten 6 mm
Profils pour plaques plates 6 mm

| Artikel-Bezeichnung Description d'article | Art.-Nr. No d'article | Länge mm Longueur mm | Preis/Stk. Prix/pce |
|--|--------------------------|-------------------------|------------------------|
| U-Profil aus Alu Profilé U en alu  | 3349.999 | 750 | 2.50 |
| | 3350.000 | 1050 | 3.00 |
| | 3350.001 | 1500 | 4.30 |
| U-Profil aus Polycarbonat Profilé U en polycarbonate  | 3200.510 | 1050 | 5.50 |
| | 3200.505 | 2100 | 10.00 |
| H-Profil aus Polycarbonat Profilé H en polycarbonate  | 3200.548 | 2000 | 20.00 |
| | 3200.540 | 3000 | 27.00 |
| | 3200.535 | 6000 | 54.00 |



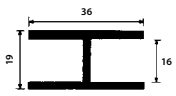
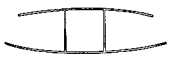
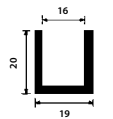
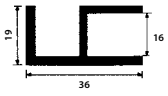
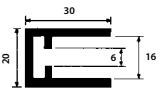

Profil für Flachplatten 10 mm
Profils pour plaques plates 10 mm

| Artikel-Bezeichnung Description d'article | Art.-Nr. No d'article | Länge mm Longueur mm | Preis/Stk. Prix/pce |
|---|--------------------------|-------------------------|------------------------|
| U-Profil aus Polycarbonat Profilé U en polycarbonate  | 3200.520 | 1050 | 5.00 |
| | 3200.515 | 2100 | 10.00 |
| H-Profil aus Polycarbonat Profilé H en polycarbonate  | 3200.565 | 1500 | 15.00 |
| | 3200.560 | 3000 | 30.00 |
| | 3200.555 | 6000 | 60.00 |

Profile für Flachplatten 16 mm
 Profilés pour plaques plates 16 mm

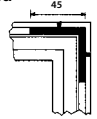
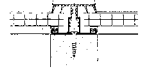
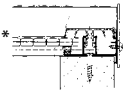
| Artikel-Bezeichnung Description d'article | Art.-Nr. No d'article | Länge mm Longueur mm | Preis/Stk. Prix/pce |
|---|--------------------------|-------------------------|------------------------|
| H-Profil aus Alu Profilé H en alu  | 3160.050 | 1500 | 9.00 |
| | 3160.051 | 2000 | 12.00 |
| | 3160.052 | 2500 | 15.00 |
| | 3160.053 | 3000 | 19.00 |
| | 3160.054 | 6000 | 38.00 |
| H-Profil aus Polycarbonat Profilé H en polycarbonate  | 3200.585 | 1500 | 25.00 |
| | 3200.580 | 3000 | 50.00 |
| | 3200.575 | 6000 | 100.00 |
| U-Profil aus Alu Profilé U en alu  | 3160.056 | 1500 | 6.50 |
| | 3160.057 | 2000 | 8.00 |
| | 3160.058 | 2500 | 10.00 |
| | 3160.059 | 3000 | 12.50 |
| | 3160.060 | 6000 | 25.00 |
| Eckprofil aus Alu Profilé d'angle en alu  | 3160.062 | 1500 | 10.00 |
| | 3160.063 | 2000 | 13.50 |
| | 3160.064 | 2500 | 17.00 |
| | 3160.065 | 3000 | 20.50 |
| | 3160.066 | 6000 | 41.00 |
| Rahmenprofil aus Alu Profilé d'encadrement en alu  | 3160.068 | 1500 | 12.00 |
| | 3160.069 | 2000 | 16.00 |
| | 3160.070 | 2500 | 20.00 |
| | 3160.071 | 3000 | 24.00 |
| | 3160.072 | 6000 | 48.00 |

Profile für Flachplatten 16 mm
 Profilés pour plaques plates 16 mm

| Artikel-Bezeichnung Description d'article | Art.-Nr. No d'article | Länge mm Longueur mm | Preis/Stk. Prix/pce |
|---|--------------------------|-------------------------|------------------------|
| Eckverbindungswinkel aus Alu Cornière de jonction en alu Set à 4 Stk./pces  | 3160.074 | | 4.90 |
| Profilsprosse aus Alu inkl. PVC-Deckleiste und Gummidichtung* Profilé d'assemblage en alu avec profilé de recouvrement en PVC*  | 3320.053 | 3500 | 95.00 |
| | 3320.054 | 7000 | 190.00 |
| Randprofilsprosse aus Alu inkl. PVC-Deckleiste* Profilé d'assemblage de bordure en alu avec profilé de recouvrement en PVC*  | 3320.063 | 3500 | 120.00 |
| | 3320.064 | 7000 | 240.00 |
| Rückhalteblech aus Alu* Equerres en alu* 40 x 40 mm  | 3320.075 | | 2.50 |
| U-Profil aus Polycarbonat Profilé U en polycarbonate  | 3200.591 | 1050 | 5.00 |
| | 3200.592 | 2100 | 10.00 |
| Abschluss-Profil aus Alu Profilé d'obturation en alu  | 3320.070 | 980 | 6.00 |
| Abschluss-Profil «T» aus Alu Profilé d'obturation «T» en alu  | 3320.072 | 980 | 6.50 |

* Für Plattenstärken 6 / 10 + 16 mm

* Pour plaques 6 / 10 + 16 mm

Profile für Flachplatten 20 mm
 Profilés pour plaques plates 20 mm

| Artikel-Bezeichnung Description d'article | Art.-Nr. No d'article | Länge mm Longueur mm | Preis/Stk. Prix/pce |
|---|--------------------------|-------------------------|------------------------|
| Rahmenprofil aus Alu Profilé d'encadrement en alu | 3170.310 | 2000 | 20.00 |
| | 3170.325 | 6000 | 60.00 |
| Eckverbindungswinkel aus Alu Cornière de jonction en alu | 3170.330 | | 6.00 |
| Set à 4 Stk./pces | | | |

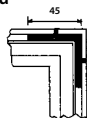
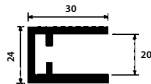

Winkelprofile
 Profilés cornières

| Artikel-Bezeichnung Description d'article | Art.-Nr. No d'article | Länge mm Longueur mm | Preis/lm Prix/lm |
|--|--------------------------|-------------------------|---------------------|
| Winkelprofile Alu, gleichschenkelig Profilé cornières alu, à ailes égales alu | 0728.542 | 50/50/2 | 13.00 |
| Lagerlänge / Longueur ca. 6000 mm | | | |



Universalprofil aus Alu, zu Flachplatten 2–10 mm
 Profilé universel en alu, pour plaques de 2–10 mm

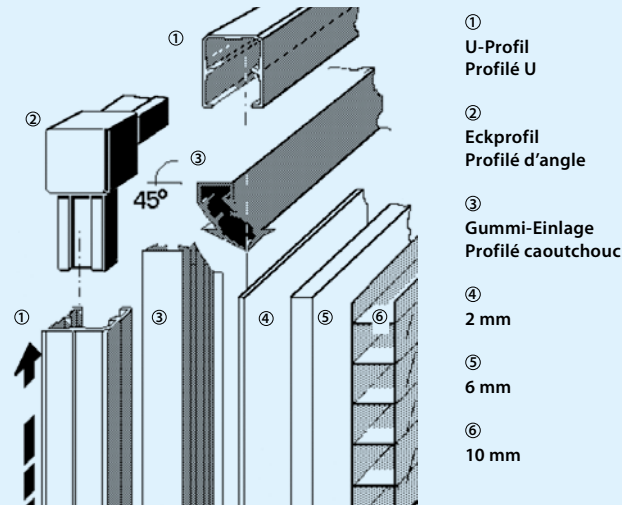

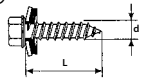

| Artikel-Bezeichnung Description d'article | Art.-Nr. No d'article | Länge mm Longueur mm | Preis/Stk. Prix/pce |
|--|--------------------------|-------------------------|------------------------|
| U-Universalprofil 2–10 mm, inkl. Gummieinlage Profilé universel U 2–10 mm, incl. caoutchouc | 3160.110 | 475 | 11.50 |
| | 3160.111 | 975 | 16.50 |
| | 3160.112 | 1975 | 22.50 |
| Eckprofil Profilé d'angle Set à 4 Stk./pces | 3160.119 | PC | 7.50 |

Befestigungsmaterial für Wellplatten Matériel de fixation pour plaques ondulées





| Artikel-Bezeichnung Description d'article | Art.-Nr. No d'article | Dimension Dimension | Packung à Stk. Paquet à pces | Preis Prix |
|--|--------------------------|------------------------|---------------------------------|---------------|
| Plastik-Rondelle bombiert, mit U-Scheibe Rondelle plastique bombée, avec rondelle  | 3400.042 | 20 × 6 | 10 | 2.30 |
| Fabco-Schrauben für Holz mit Dichtscheibe Stahl 18/8 S 19 Vis Fabco pour bois Rondelle d'étanchéité acier 18/8 S 19  | 3400.142 | 6,5 × 51 | 250 | 148.00 |

Befestigungsmaterial für Wellplatten Matériel de fixation pour plaques ondulées



| Artikel-Bezeichnung Description d'article | Art.-Nr. No d'article | Dimension Dimension | Packung à Stk. Paquet à pces | Preis Prix |
|---|--------------------------|------------------------|---------------------------------|---------------|
| Stützbügel S 70/18 Support S 70/18  | 3400.011 | S 70/18 | 10 | 2.95 |
| Stützbügel 76/18 Support 76/18  | 3400.026 | 76/18 | 10 | 2.95 |
| Stützbügel 177/51 Support 177/51  | 3400.088 | 177/51 | 25 | 12.00 |



Befestigungsmaterial für Wellplatten Matériel de fixation pour plaques ondulées



| Artikel-Bezeichnung Description d'article | Art.-Nr. No d'article | Packung à Stk. Paquet à pces | Preis/Stk. Prix/pce |
|---|--------------------------|---------------------------------|------------------------|
| Befestigungs-Set für Wellung S 70/18: Holzschrauben verz. 5 × 50 Metall-U-Scheiben verz. 5 × 15 × 1 Spezial-Rondellen weiss Set de fixation pour ondulation S 70/18: <i>vis à bois galv. 5 × 50</i> <i>rondelles galv. 5 × 15 × 1</i> <i>rondelles spéc. blanche</i>  | 3400.005 | 20 | 6.80 |
| Befestigungs-Set für Wellung 76/18: Holzschrauben verz. 5 × 50 Metall-U-Scheiben verz. 5 × 15 × 1 Plastik-Rondellen bombiert Set de fixation pour ondulation 76/18: <i>vis à bois galv. 5 × 50</i> <i>rondelles galv. 5 × 15 × 1</i> <i>rondelles plastiques bombées</i>  | 3400.020 | 20 | 6.80 |
| Befestigungs-Set für Wellung NP 65: Fabco-Schrauben für Holz 76 × 18 und Trapez Dichtscheiben S.19 Set de fixation pour ondulation NP 65: <i>vis Fabco pour bois 76 × 18 et trapèze</i> <i>rondelles d'étanchéité S.19</i>  | 3400.045 | 20 | 12.60 |
| | 3400.046 | 10 | 5.95 |
| Befestigungs-Set für Wellung 177/51: Holzschrauben verz. 7 × 90 Metall-Rondellen verz. 25 × 7 Gummi-Rondellen Set de fixation pour ondulation 177/51: <i>vis à bois galv. 7 × 90</i> <i>rondelles galv. 25 × 7</i> <i>rondelles caoutchouc</i>  | 3400.087 | 20 | 8.00 |

Befestigungsmaterial für Wellplatten
Matériel de fixation pour plaques ondulées

| Artikel-Bezeichnung Description d'article | Art.-Nr. No d'article | Länge mm Longueur mm | Preis/Stk. Prix/pce |
|--|--------------------------|-------------------------|------------------------|
| Dichtungsstreifen S 70/18 Bande d'étanchéité S 70/18  | 3400.018 | 1050 | 4.50 |
| Dichtungsstreifen 76/18 Bande d'étanchéité 76/18  | 3400.036 | 850 | 4.50 |

| Artikel-Bezeichnung Description d'article | Art.-Nr. No d'article | Inhalt Capacité | Preis/Stk. Prix/pce |
|---|--------------------------|--------------------|------------------------|
| Kitt für Polycarbonate, farblos Mastic pour polycarbonate, transparent  | 3400.086 | 60 ml | 12.90 |
| PVC-Kleber Colle pour PVC  | 0871.610 | 250 ml | 17.50 |

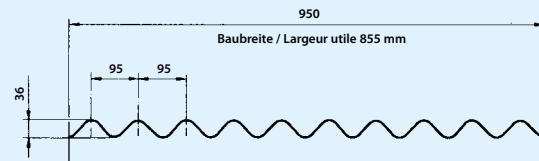

Onduline Bitumen-Wellplatten, Wellung 95/36
Onduline plaques ondulées en bitumen, Ondulation 95/36

| Art.-Nr. No d'article | Farbe Couleur | Länge mm Longueur mm | Breite mm Largeur mm | Preis/Stk. Prix/pce |
|--------------------------|------------------|-------------------------|-------------------------|------------------------|
| 3150.005 | braun / brun | 2000 | 950 | 22.50 |
| 3150.010 | grün / vert | 2000 | 950 | 22.50 |
| 3150.015 | rot / rot | 2000 | 950 | 22.50 |
| 3150.020 | schwarz / noir | 2000 | 950 | 22.50 |

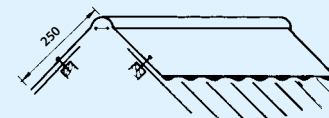

Onduline Firststücke
Faitières Onduline

| Art.-Nr. No d'article | Farbe Couleur | Länge mm Longueur mm | Breite mm Largeur mm | Preis/Stk. Prix/pce |
|--------------------------|------------------|-------------------------|-------------------------|------------------------|
| 3150.050 | braun / brun | 900 | 500 | 8.80 |
| 3150.055 | grün / vert | 900 | 500 | 8.80 |
| 3150.060 | rot / rot | 900 | 500 | 8.80 |
| 3150.065 | schwarz / noir | 900 | 500 | 8.80 |

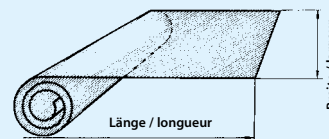

Bitumenbahn mit Glasvlies, V50
Carton bituminé renforcé V50

| Art.-Nr. No d'article | Länge m Longueur m | Breite m Largeur m | Preis/Rolle Prix/rouleau |
|--------------------------|-----------------------|-----------------------|-----------------------------|
| 3150.086 | 20 | 1 | 59.00 |

Schindeln-Rechteck
Bardeaux rectangulaires

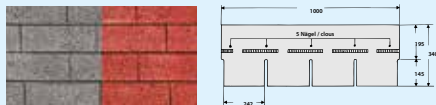

| Art.-Nr. No d'article | Farbe Couleur | Packung à Stk.* Paquet à pces* | Preis/Stk. Prix/pce |
|--------------------------|------------------|-----------------------------------|------------------------|
| 0812.000 | rot / rouge | 21 | 50.00 |
| 0812.080 | schwarz / noir | 21 | 50.00 |

* Ein Paket deckt 3 m² Dachfläche. / Un paquet couvre 3 m² de toiture.

Schindeln-Biberschwanz
Bardeaux Biber

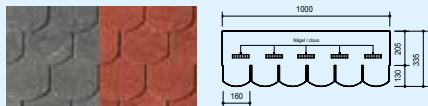

| Art.-Nr. No d'article | Farbe Couleur | Packung à Stk.* Paquet à pces* | Preis/Stk. Prix/pce |
|--------------------------|------------------|-----------------------------------|------------------------|
| 0812.011 | rot / rouge | 21 | 60.00 |
| 0812.081 | schwarz / noir | 21 | 60.00 |

* Ein Paket deckt 3 m² Dachfläche. / Un paquet couvre 3 m² de toiture.

Bardoline-Tegola
Bitumen-Schindeln,
Rechteckig, 100 × 34 cm
Bardoline-Tegola,
bardeaux canadien en bitumen,
rectangulaire, 100 × 34 cm



| Art.-Nr. No d'article | Farbe Couleur | Packung à Stk.* Paquet à pces* | Preis/Stk. Prix/pce |
|--------------------------|------------------|-----------------------------------|------------------------|
| 3150.090 | braun / brun | 24 | 68.00 |

* Ein Paket deckt 3,5 m² Dachfläche. / Un paquet couvre 3,5 m² de toiture.

Bardoline-Tegola
Bitumen-Schindeln,
Biber, 100 × 34 cm
Bardoline-Tegola,
forme tuile plat, 100 × 34 cm

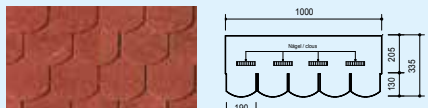

| Art.-Nr. No d'article | Farbe Couleur | Packung à Stk.* Paquet à pces* | Preis/Stk. Prix/pce |
|--------------------------|------------------|-----------------------------------|------------------------|
| 3150.093 | rot / rouge | 24 | 68.00 |

* Ein Paket deckt 3,5 m² Dachfläche. / Un paquet couvre 3,5 m² de toiture.

Befestigungsmaterial für Bitumenplatten
Matériel de fixation pour plaques bitumen

| Artikel-Bezeichnung Description d'article | Art.-Nr. No d'article | Länge mm Longeur mm | Packung à Stk. Paquet à pces | Preis Prix |
|--|--------------------------|------------------------|---------------------------------|---------------|
| Stützbügel für Onduline Support pour Onduline | 3150.072 | | 5 | 1.90 |
| | | | | |
| Onduline Nägel Clous Onduline | 3400.049 | 70 | 20 | 2.50 |
| | | | | |
| Dichtungstreifen für Onduline Bande d'étanchéité pour Onduline | 3400.056 | 860 | 1 | 5.60 |
| | | | | |
| Bardoline-Tegola- Befestigungsstifte, verzinkt Clous fixation Bardoline- Tegola, galvanisé | 3400.060 | | 100 | 3.80 |
| | | | | |

DACHRINNE · GOÜTTIÈRE



| Art.-Nr. No d'article | Beschreibung Description | Preis Prix |
|--------------------------|--|---------------|
| 0812.213 | Dachrinne Set 1, beidseitig 3 m <i>Kit gouttière 1, deux côtés, 3m</i> | 250.00 |
| 0812.201 | Dachrinne Set 2, beidseitig 4 m <i>Kit gouttière 2, deux côtés, 4 m</i> | 280.00 |
| 0812.202 | Dachrinnen-Verlängerung, 2 m <i>Prolongation de gouttière, 2 m</i> | 150.00 |

Ihr Gartenfachgeschäft in der Nähe:
Votre commerce spécialisé pour produits de jardinage:

Neogard AG, 5728 Gontenschwil | www.neogard.ch

0100.017 - 04/16 Modell- und Preisänderungen vorbehalten.
Exkl. Transport. Gedruckt in der Schweiz.
04/16 Sous réserve de changement de modèle et de prix.
Sans frais de transport. Imprimé en Suisse.

neogard
im Garten gut beraten